



EASY GLASS® SMART UND EASY GLASS® PRIME

**ZWEI EINZIGARTIGE GLASGELÄNDER,  
FÜNF MONTAGEVORTEILE**



Q-DISC® SYSTEM:

# DIE REVOLUTION BEI DER GLASGELÄNDERMONTAGE

Das Q-disc System, das mit dem renommierten Red Dot Design Award ausgezeichnet ist, ist ganz anders als andere Systeme zur Befestigung von Glas bei Ganzglasgeländern. Es ist zudem in einer nicht justierbaren und justierbaren Variante erhältlich.

SO FUNKTIONIERT'S **NICHT JUSTIERBARES Q-DISC SYSTEM: SCHRITTE 1 - 4** **JUSTIERBARES Q-DISC SYSTEM: SCHRITTE 1 - 8**

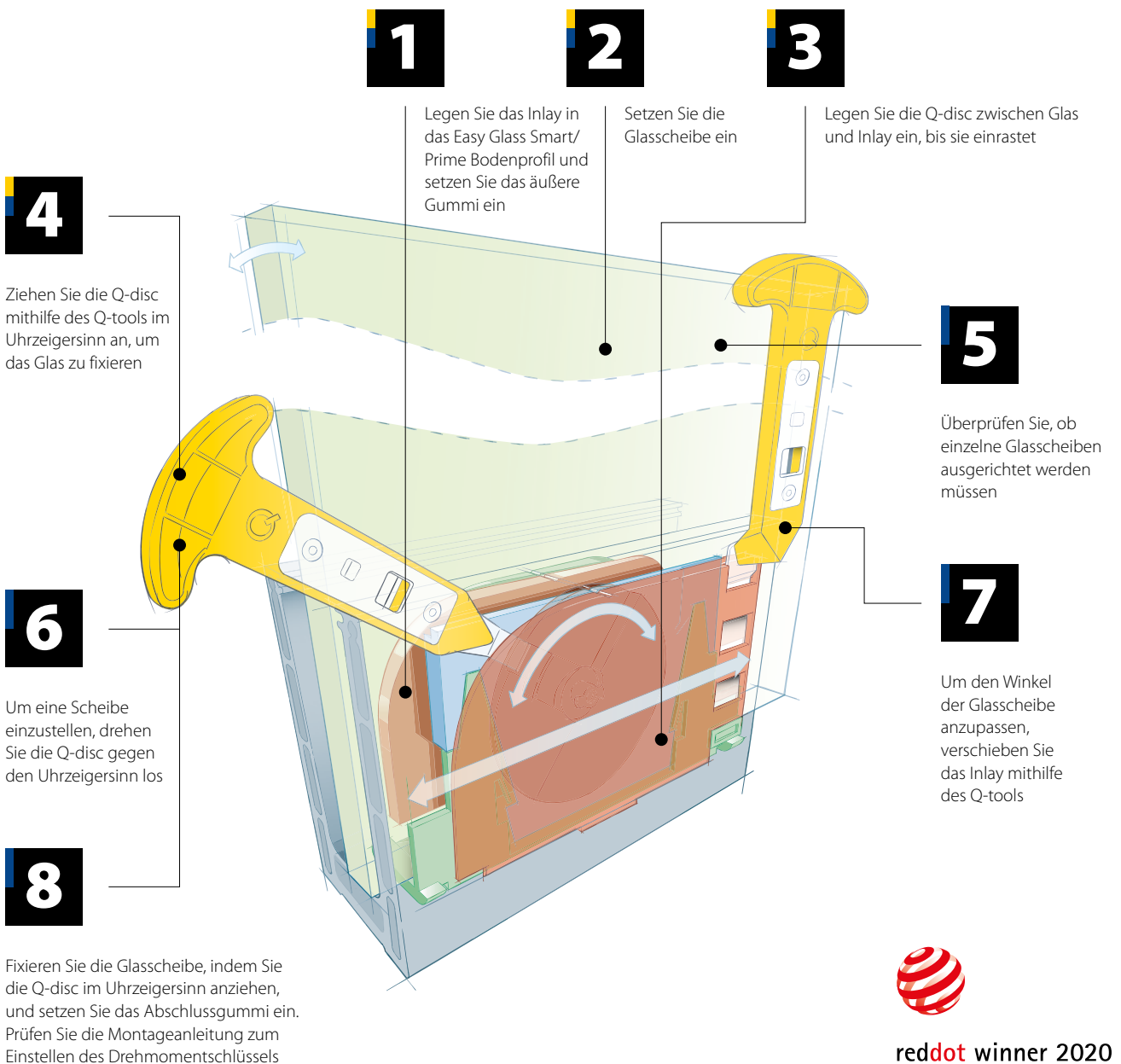

reddot winner 2020  
innovative product

# AUS MONTAGE- HERAUSFORDERUNG WIRD MONTAGEKOMFORT

## EASY GLASS® SMART UND EASY GLASS® PRIME

Easy Glass® Smart und Easy Glass® Prime sind anders als herkömmliche Glasgeländer. Dank des revolutionären Q-disc® Systems bieten beide Geländer eine ganz neue Weise, Glasfüllungen zu montieren und auszurichten. Das geht jetzt schneller als je zuvor! Und was sogar noch besser ist: Die beiden Glasgeländer lösen tägliche Montageherausforderungen, die Sie bisher erlebt haben.



# IHRE 5 MONTAGEVORTEILE AUF EINEN BLICK

1

## MONTIEREN MIT DEM EINFACHSTEN ANKER

Wählen Sie einen Anker Ihrer Wahl. Die Bodenprofile sind für den Einsatz verschiedener Anker geeignet – Senkkopfanker sind nicht erforderlich. Und dank der größeren Bohrungen in den Smart und Prime Bodenprofilen ist die Montage mit einem Steckschlüssel einfach und die Verankerung unkompliziert. Dies gilt auch für Holz- und Stahluntergründe.

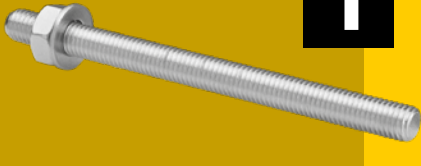

2

## SETZEN SIE GLASSCHEIBEN UND BLENDLEISTEN SICHER UND EINFACH EIN

Die bodenmontierten Smart und Prime Profile sind symmetrisch. Daher ist es bei der Glasmontage egal, welche Seite des Profils nach innen zeigt – es kann nichts schiefgehen. Mithilfe der Bauanschlussleisten-/Trenngummis sorgen Sie für genügend Abstand zwischen den Glasscheiben und minimieren das Risiko für Glasschäden beim Montieren.

Alle Installationsarbeiten werden von der Innenseite des Balkons erledigt – auch das Anbringen der Blendleisten. Im Gegensatz zu anderen Artikeln können die Blendleisten sofort an den Bodenprofilen angebracht werden – Sie müssen nicht warten, bis das Glas eingesetzt wird.



3

## DIREKT WISSEN, OB DAS GLAS RICHTIG EINGESETZT IST

Die Glasmontage könnte mit diesen Geländern nicht einfacher sein. Die Q-disc gibt Ihnen direktes Feedback bei der Installation – durch ein deutliches Klickgeräusch wird signalisiert, dass alles richtig eingesetzt ist. Zudem können Sie bereits während der Montage einschätzen, wie die Glasscheiben stehen, wenn Sie zuerst die äußeren Discs einsetzen. Sie können damit also früher als bisher die Ausrichtung prüfen und korrigieren.



4

## MEISTERN SIE UNEBENE BÖDEN

Dank der passenden Unterlegscheiben können Sie Unebenheiten ausgleichen und somit die Bodenprofile bequem montieren. Und mit den F- und Y-Profilen können Sie das Geländer direkt an oder über die Bodenkante hinaus anbringen. Praktisch sind auch die Bauanschlussleisten, um Lücken zwischen Profil und Bodenbelag zu verdecken. So erhalten Sie, unabhängig vom Ausgangspunkt, ein perfektes Endergebnis.



5

## SCHAFFEN SIE EINE NAHTLOSE VERBINDUNG MIT DEM BODENBELAG

Oft wird viel Zeit dazu gebraucht, Lücken zu schließen und einen nahtlosen Anschluss zum angrenzenden Boden zu kreieren. Diese Zeiten sind nun vorbei. Mit den einfach zu installierenden Bauanschlussleisten gehören sichtbare Übergänge und Spalten der Vergangenheit an. Sie erhalten eine makellose, flache Verbindung zwischen Profil und Boden. Noch mehr Zeit sparen Sie mit dem Einsatz der Bauanschlussleisten-/Trenngummis, die die Leisten während der Montagearbeiten am Platz halten.



SEHEN SIE SICH ALLE VIDEOS ZU DEN MONTAGEVORTEILEN AN:

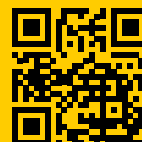

[q-ne.ws/smart-prime](https://q-ne.ws/smart-prime)

# WIE ENTSCHEIDEN SIE SICH?

Egal ob Sie Easy Glass Smart oder Easy Glass Prime installieren, beide Glasgeländer verfügen über das ausgezeichnete Q-disc System für die einfachste Glasmontage. Sie können aus vier unterschiedlichen Bodenprofile wählen. Die F- und Y-förmigen Profile sind speziell für Rohfußböden und die Montage direkt an oder über die Bodenkante hinaus entwickelt. Easy Glass Smart ist das ideale Glasgeländer für Bereiche mit leichter und mittlerer Beanspruchung – beispielsweise bei privaten Bauobjekten oder Mehrfamilienhäuser. Wählen Sie Easy Glass Prime, wenn Sie Glasgeländer für Projekte mit einer mittleren Beanspruchung benötigen – wie Geländer in öffentlichen Gebäuden wie Bürogebäude oder Einkaufszentren.



6 - 19



20 - 35

## EASY GLASS® SMART

**Glasfixierung:** Q-disc  
**Glasstärke:** 12 bis 21,52 mm (nicht justierbar)  
 12 bis 17,52 mm (justierbar)  
**Einstellbarkeit:** 0,6° (vertikal)



✓ Statisch berechnet gemäß DIN18008 und AbP geprüft

Die genannten Werte sind gültig für die gängigsten Bauvorhaben und stammen aus der prüffähigen Typenstatik. Die gezeigte Empfehlung basiert auf einen Einbau laut Angaben in den Querschnitten (unten auf dieser Seite). Bitte beachten Sie die Besonderheiten bei Ihrem Bauvorhaben wie Windlasten, Holmlasten und Befestigungsuntergrund.

## EASY GLASS® PRIME

**Glasfixierung:** Q-disc  
**Glasstärke:** 16,76 bis 25,52 mm (justierbar)  
**Einstellbarkeit:** 1,2° (vertikal)



✓ Statisch berechnet gemäß DIN18008 und AbP geprüft

Die genannten Werte sind gültig für die gängigsten Bauvorhaben und stammen aus der prüffähigen Typenstatik. Die gezeigte Empfehlung basiert auf einen Einbau laut Angaben in den Querschnitten (unten auf dieser Seite). Bitte beachten Sie die Besonderheiten bei Ihrem Bauvorhaben wie Windlasten, Holmlasten und Befestigungsuntergrund.

					SMART VS. PRIME: UNSERE EMPFEHLUNG														
	MOD 8210	MOD 8220	MOD 8230	MOD 8240	Verbund-sicherheitsglas		Verbund-sicherheitsglas	MOD 8410	MOD 8420	MOD 8430	MOD 8440		Verbund-sicherheitsglas	MOD 8410	MOD 8420	MOD 8430	MOD 8440		
<b>INDOOR</b>	✓	✓	✓	✓	16,76 - 17,52 mm	← Privat	0,5 kN/m	16,76 - 17,52 mm	✓	✓	✓	✓	20,76 - 21,52 mm	✓	✓	✓	✓	<b>INDOOR</b>	
<b>OUTDOOR</b>	✓	✓	✓	✓				20,76 - 21,52 mm	✓	✓	✓	✓		✓	✓	✓	20,76 - 21,52 mm	1,7	2,1
Windlast (kN/m <sup>2</sup> )	1,4	1	1	1															Windlast (kN/m <sup>2</sup> )
<b>INDOOR</b>	✓	✓	✓	✓	20,76 - 21,52 mm*	1 kN/m	Öffentlich →	20,76 - 21,52 mm	✓	✓	✓	✓	20,76 - 21,52 mm	✓	✓	✓	✓	<b>INDOOR</b>	
<b>OUTDOOR</b>	✓	✓	✓	✓					20,76 - 21,52 mm*	✓	✓	✓		✓	✓	✓	✓		20,76 - 21,52 mm
Windlast (kN/m <sup>2</sup> )	0,6	0,8	1	1,5															Windlast (kN/m <sup>2</sup> )

\*Nur mit nicht justierbarem Q-disc System

EASY GLASS® SMART

Smart / Prime  
MOD 8210 / 8410  
Bodenmontage

Smart F / Prime F  
MOD 8220 / 8420  
Bodenmontage

Smart / Prime  
MOD 8230 / 8430  
Seitenmontage

Smart Y / Prime Y  
MOD 8240 / 8440  
Seitenmontage

EASY GLASS® PRIME



Zertifikate und Details  
q-ne.ws/3kkmkbal

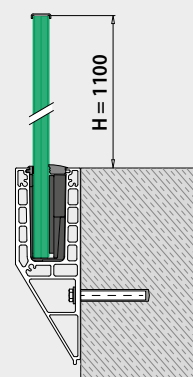
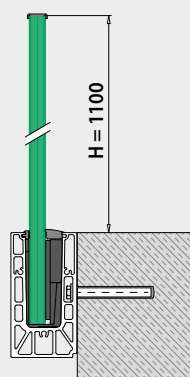
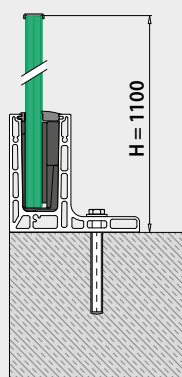
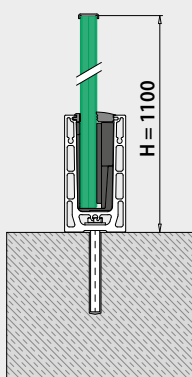

Zertifikate und Details  
q-ne.ws/3zdgkma

# EASY GLASS® SMART

## MIT NICHT JUSTIERBAREM ODER JUSTIERBAREM Q-DISC® SYSTEM

### Smart Bodenmontage

- Symmetrisches Bodenprofil
- Auch für die In-Bodenmontage

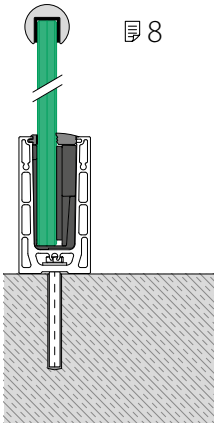

### Smart F Bodenmontage

- Für Rohfußböden
- Kann direkt an oder über der Bodenkante angebracht werden

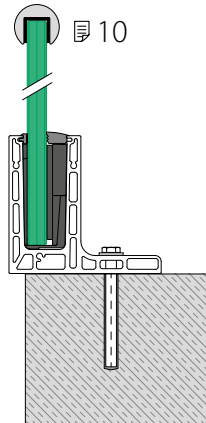

### Smart Seitenmontage

- Auch zur Montage an der Innenseite von Aufmauerungen
- Bodenprofil-Blendleiste erhältlich

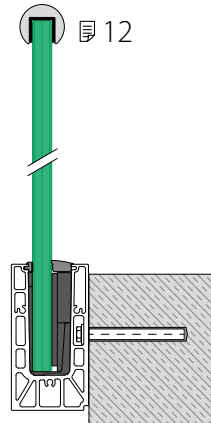

### Smart Y Seitenmontage

- Für Rohfußböden
- Kann direkt an oder über der Bodenkante angebracht werden
- Bodenprofil-Blendleiste erhältlich

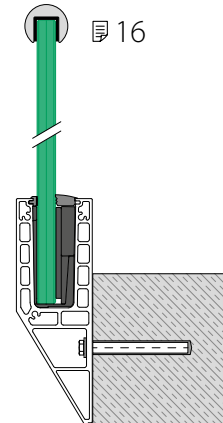

- 1 Mit dem justierbaren Q-disc System können Sie die Glasscheiben um bis zu 0,6° in der Vertikalen ausrichten.
- 2 Mit einem Klickgeräusch signalisiert die Q-disc die korrekte Montage.
- 3 Geeignet für Glasstärken zwischen 12 und 21,52 mm.

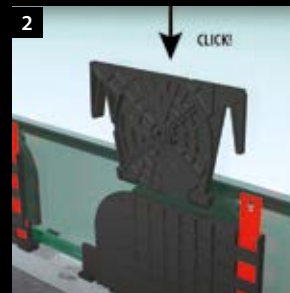

### EINFACHE MONTAGE: BODENUNEVENHEITEN MIT UNTERLEGSCHLEIBEN AUSGLEICHEN

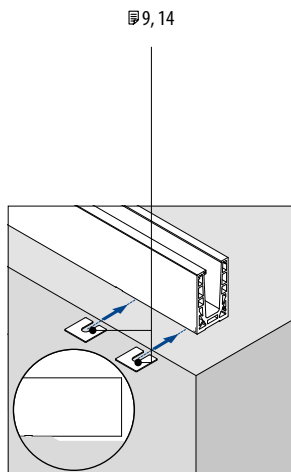

#### Füllung ☐ 44



#### Glasabschluss und Handlauf ☐ 36 - 38



#### Beleuchtung Siehe Produktkatalog ☐ 164 - 187

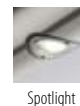

#### Prefix ☐ 46



#### Extras



## Q-disc® System (Gummi, Inlay und Q-disc®)

## Glasklemmung und -justierung

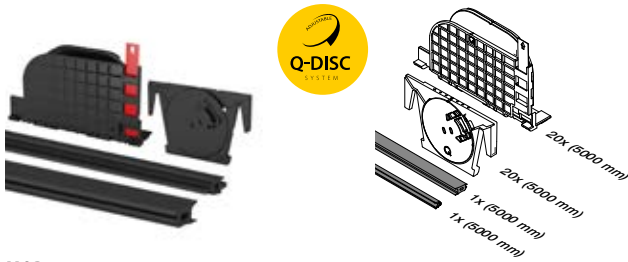

## MOD 8201

Zubehör		
Mono.	T	
208201-050-12	12	L = 5000 mm
208201-050-15	15	L = 5000 mm
208201-250-12	12	L = 25 m
208201-250-15	15	L = 25 m
Lam.		
Lam.	T	
208201-050-13	12,76 (6-0,76-6)	L = 5000 mm
208201-050-14	13,52 (6-1,52-6)	L = 5000 mm
208201-050-17	16,76 (8-0,76-8)	L = 5000 mm
208201-050-18	17,52 (8-1,52-8)	L = 5000 mm
208201-250-13	12,76 (6-0,76-6)	L = 25 m
208201-250-14	13,52 (6-1,52-6)	L = 25 m
208201-250-17	16,76 (8-0,76-8)	L = 25 m
208201-250-18	17,52 (8-1,52-8)	L = 25 m



reddot winner 2020

Internationaler Geschmacksmusterschutz

## Q-disc®- und Inlay-Werkzeug

## Glasklemmung und -justierung



## MOD 1000

Zubehör		
	Q	
201000	Q-84	1

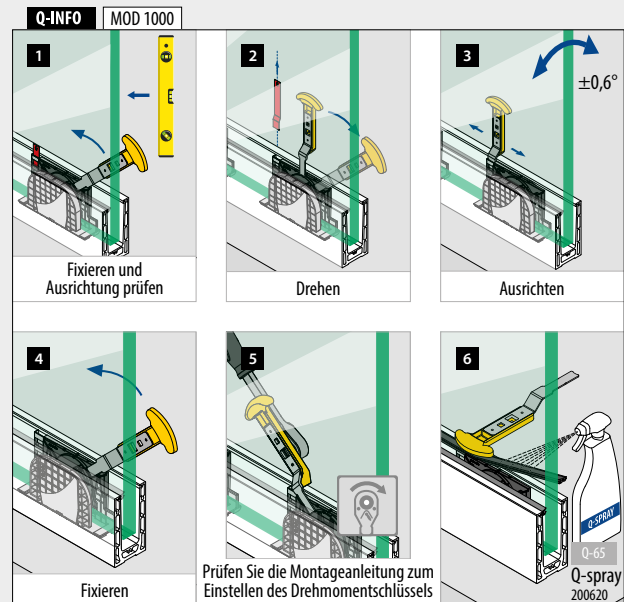

## Q-disc® System (Gummi, Inlay und Q-disc®)

## Glasklemmung (nicht justierbar)

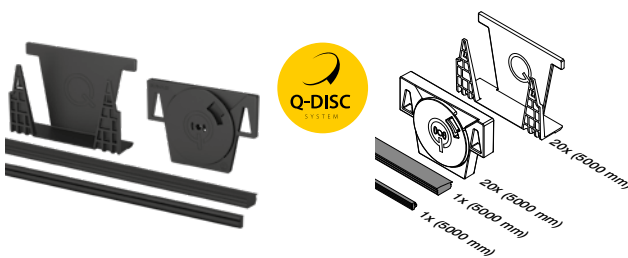

## MOD 8200

Zubehör		
Mono.	T	
208200-050-12	12	L = 5000 mm
208200-050-15	15	L = 5000 mm
208200-050-19	19	L = 5000 mm
Lam.		
Lam.	T	
208200-050-13	12,76 (6-0,76-6) - 13,52 (6-1,52-6)	L = 5000 mm
208200-050-17	16,76 (8-0,76-8) - 17,52 (8-1,52-8)	L = 5000 mm
208200-050-21	20,76 (10-0,76-10) - 21,52 (10-1,52-10)	L = 5000 mm
208200-250-13	12,76 (6-0,76-6) - 13,52 (6-1,52-6)	L = 25 m
208200-250-17	16,76 (8-0,76-8) - 17,52 (8-1,52-8)	L = 25 m
208200-250-21	20,76 (10-0,76-10) - 21,52 (10-1,52-10)	L = 25 m



reddot winner 2020

Internationaler Geschmacksmusterschutz

## Q-disc®-Werkzeug

## Glasklemmung (nicht justierbar)



## MOD 1009

Zubehör		
	Q	
201009	Q-83	1

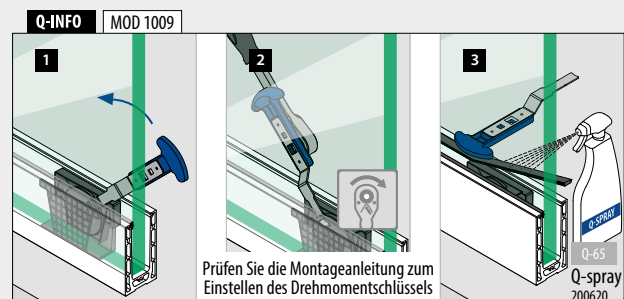

Geländerbasis

Bodenprofile zur Bodenmontage

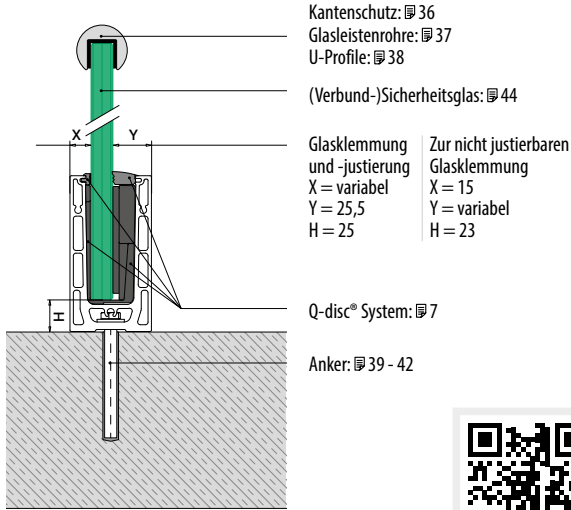

Montage-  
 informationen:  
[q-ne.ws/3wDkp1B](http://q-ne.ws/3wDkp1B)

Bitte beachten Sie die Spezifikationen wie Befestigungs- und Glasmaße sowie Glastypeen der jeweiligen Zertifikate.

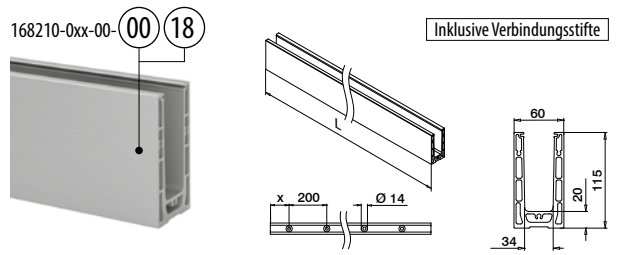

MOD 8210

Aluminium	Roh	X	39 - 42	L = 5000 mm
168210-050-00-00	100			
Aluminium	Gebürstet	X	39 - 42	L = 2500 mm
168210-025-00-18	50			
168210-050-00-18	100			L = 5000 mm



Internationaler  
 Geschmacksmusterschutz

Geländerbasis

Ecken zur Bodenmontage

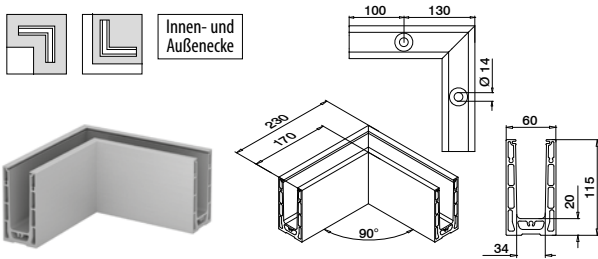

MOD 8211

Aluminium	Roh	39 - 42	1
168211-00-00			
Aluminium	Gebürstet	39 - 42	1
168211-00-18			



Internationaler Geschmacksmusterschutz

Q-INFO MOD 8210

Bauanschlussleisten: 18 - 19

MOD 8205  
 19

Bauanschlussleisten-/Trenngummi

Montagevideo:  
[q-ne.ws/2TjximV](http://q-ne.ws/2TjximV)

Q-INFO MOD 8210

PREFIX

Q-INFO

MOD 3005  
 43

Zusätzliche Verbindungsstifte

Q-INFO Aluminium

00 Roh

18 Gebürstet, anodisiert



## Endkappen zur Bodenmontage



## MOD 8212

Aluminium Roh		3M Klebeband	
168212-00-00	Beigelegt		1
Aluminium Gebürstet		3M Klebeband	
168212-00-18	OUTDOOR Angebracht		1

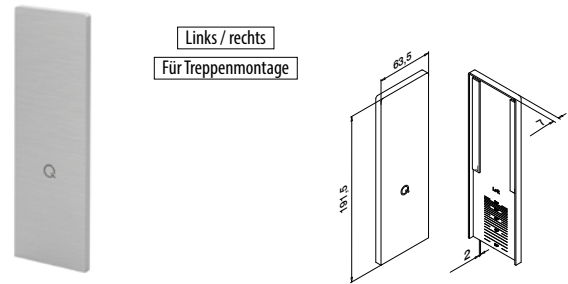

## MOD 8213

Aluminium Roh		3M Klebeband	
168213-00-00	Beigelegt		1
Aluminium Gebürstet		3M Klebeband	
168213-00-18	OUTDOOR Angebracht		1



## Unterlegscheiben zur Bodenmontage

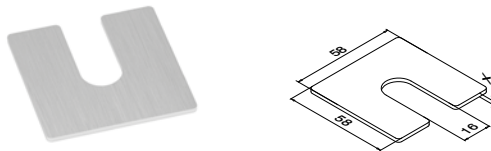

## MOD 8216

Aluminium Roh		X	
168216-001	1		100
168216-002	2		100
168216-003	3		100

## Drainageleisten zur Bodenmontage

4 Stück für 2,5-Meter-Bodenprofil  
8 Stück für 5-Meter-Bodenprofil

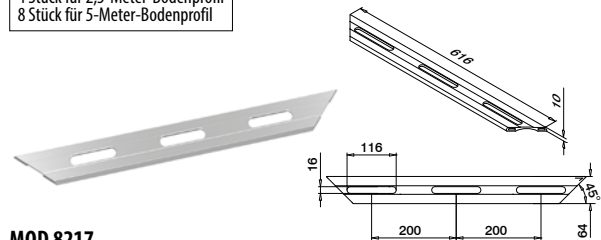

## MOD 8217

Aluminium Gebürstet			
168217-18	OUTDOOR		4

## Q-INFO MOD 8212

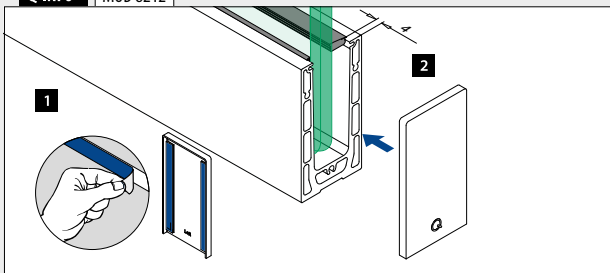

## Q-INFO MOD 8213

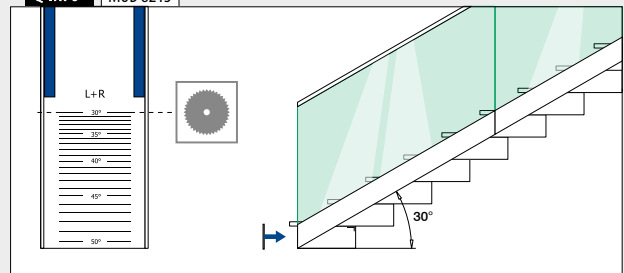

## Q-INFO MOD 8216

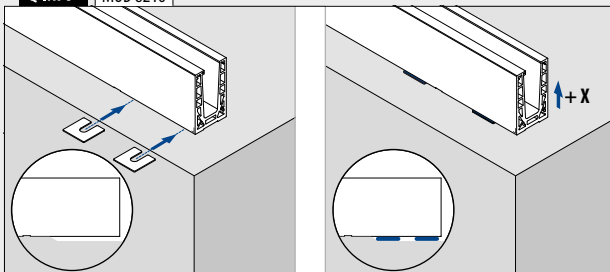

## Q-INFO MOD 8217

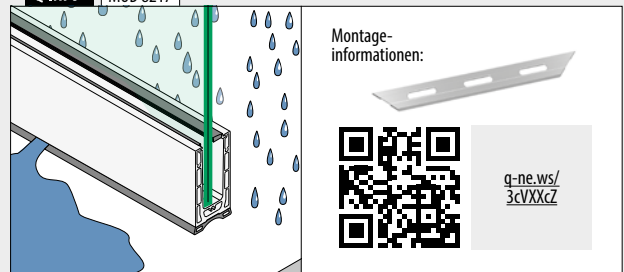

Montage-  
informationen:



q-ne.ws/  
3cVXXcZ

Geländerbasis

### Bodenprofile zur Bodenmontage

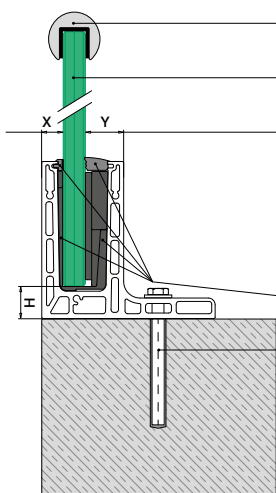

Kantenschutz: 36  
 Glasleistenrohre: 37  
 U-Profile: 38  
 (Verbund-)Sicherheitsglas: 44

Zur nicht justierbaren  
 Glasklemmung  
 X = 15,5  
 Y = variabel  
 Y = 23  
 H = 23

Q-disc® System: 7

Anker: 39 - 42



Montage-  
 informationen:  
[q-ne.ws/3wDkp18](http://q-ne.ws/3wDkp18)

Bitte beachten Sie die Spezifikationen wie Befestigungs- und Glasmaße sowie Glastypeen der jeweiligen Zertifikate.

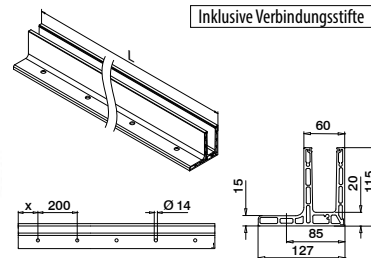
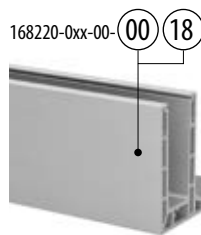

#### MOD 8220

Aluminium	Roh	X		
168220-050-00-00	100	39 - 42	L = 5000 mm	
Aluminium	Gebürstet	X		
168220-025-00-18	50	39 - 42	L = 2500 mm	
168220-050-00-18	100	39 - 42	L = 5000 mm	



Internationaler  
 Geschmacksmusterschutz

Geländerbasis

### Ecken zur Bodenmontage

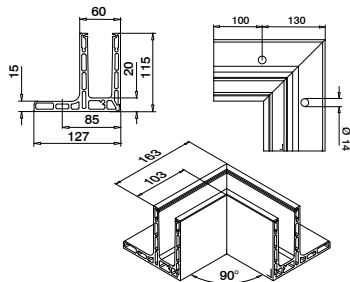
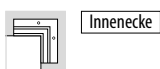

#### MOD 8221

Aluminium	Gebürstet			
168221-01-18	OUTDOOR	39 - 42	1	



Internationaler Geschmacksmusterschutz

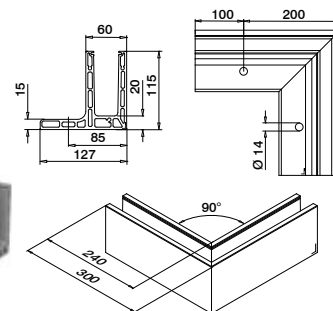

#### MOD 8221

Aluminium	Gebürstet			
168221-02-18	OUTDOOR	39 - 42	1	



Internationaler Geschmacksmusterschutz

Q-INFO

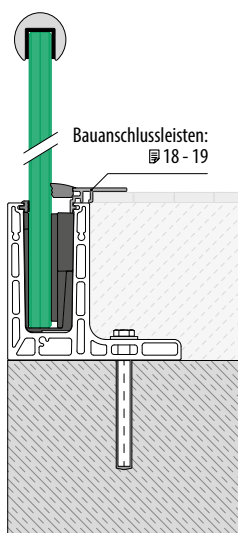

Bauanschlussleisten:  
 18 - 19

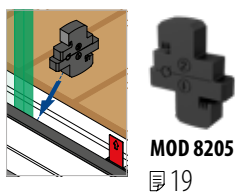

Bauanschlussleisten-/Trenngummi



Montagevideo:  
[q-ne.ws/2TjximV](http://q-ne.ws/2TjximV)

Q-INFO

MOD 8220

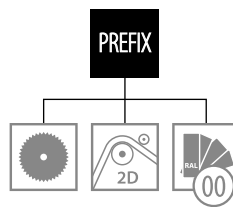

Q-INFO

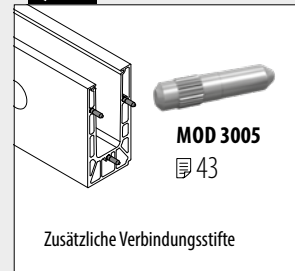

MOD 3005  
 43

Q-INFO

Aluminium

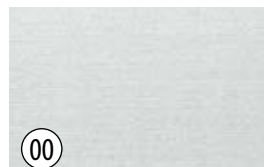

Roh

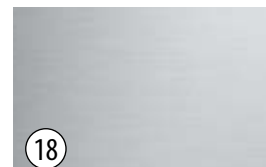

Gebürstet, anodisiert

## Endkappen zur Bodenmontage

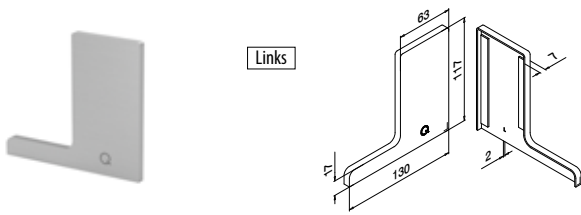

## MOD 8222

<b>Aluminium</b>	Roh		
	<b>3M Klebeband</b>		
168222-01-00	Beigelegt		1
<b>Aluminium</b>	Gebürstet		
<b>OUTDOOR</b>	<b>3M Klebeband</b>		
168222-01-18	Angebracht		1

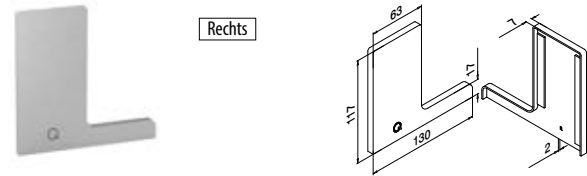

## MOD 8222

<b>Aluminium</b>	Roh		
	<b>3M Klebeband</b>		
168222-02-00	Beigelegt		1
<b>Aluminium</b>	Gebürstet		
<b>OUTDOOR</b>	<b>3M Klebeband</b>		
168222-02-18	Angebracht		1

## Q-INFO

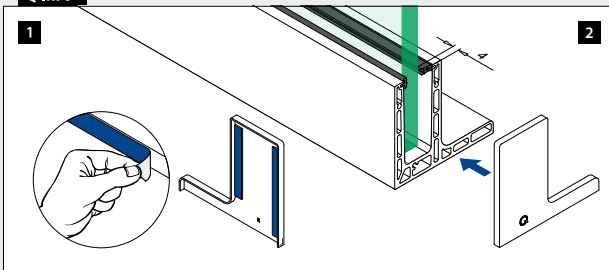

Geländerbasis

Bodenprofile zur Seitenmontage

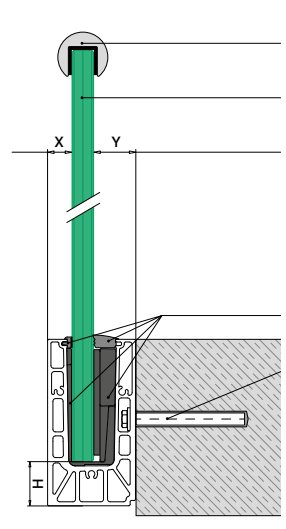

Kantenschutz: 36  
 Glasleistenrohre: 37  
 U-Profile: 38  
 (Verbund-)Sicherheitsglas: 44

Glasklemmung und -justierung  
 X = variabel  
 Y = 28,5  
 H = 35

Zur nicht justierbaren Glasklemmung  
 X = 18,5  
 Y = variabel  
 H = 33

Q-disc® System: 7  
 Anker: 39 - 42



Montage-  
 informationen:  
[q-ne.ws/3wDkp18](http://q-ne.ws/3wDkp18)

Bitte beachten Sie die Spezifikationen wie Befestigungs- und Glasmaße sowie Glastypen der jeweiligen Zertifikate.

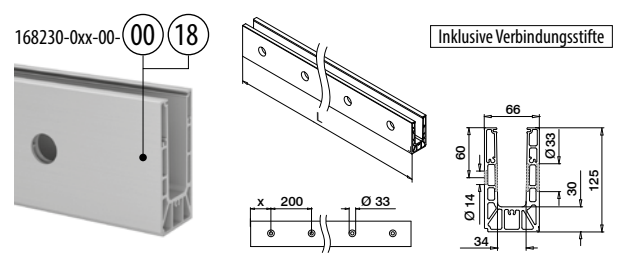

MOD 8230

Aluminium	Roh	X		
168230-050-00-00	100	39 - 42	L = 5000 mm	
Aluminium	Gebürstet	X		
168230-025-00-18	50	39 - 42	L = 2500 mm	
168230-050-00-18	100	39 - 42	L = 5000 mm	



Internationaler Geschmacksmusterschutz

Geländerbasis

Ecken zur Seitenmontage

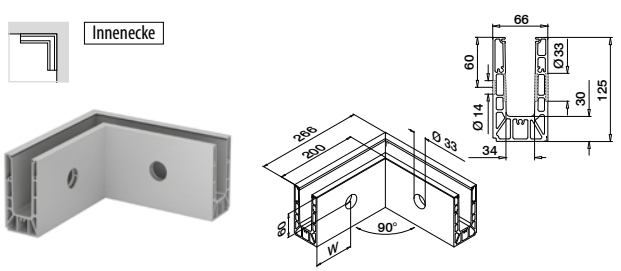

MOD 8231

Aluminium	Roh	W		
168231-01-00	100*	39 - 42	1	
Aluminium	Gebürstet	W		
168231-01-18	100*	39 - 42	1	



Internationaler Geschmacksmusterschutz

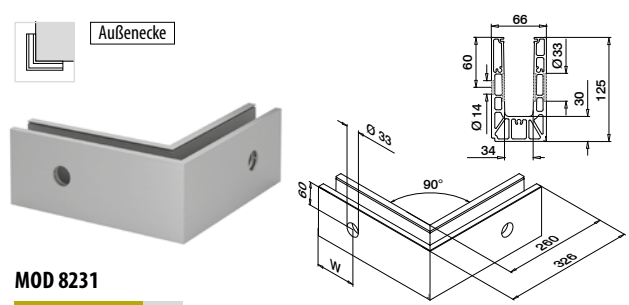

MOD 8231

Aluminium	Roh	W		
168231-02-00	100*	39 - 42	1	
Aluminium	Gebürstet	W		
168231-02-18	100*	39 - 42	1	



Internationaler Geschmacksmusterschutz

\*Die Lochposition kann produktionsbedingt um 25 mm abweichen.

Q-INFO

Bauanschlussleisten: 18 - 19

MOD 8205  
19

Bauanschlussleisten-/Trenngummi

Montagevideo:  
[q-ne.ws/2TjximV](http://q-ne.ws/2TjximV)

Q-INFO

MOD 8230

PREFIX

Q-INFO

MOD 3005  
43

Zusätzliche Verbindungsstifte

Q-INFO

Aluminium

00 Roh

18 Gebürstet, anodisiert

Endkappen zur Seitenmontage

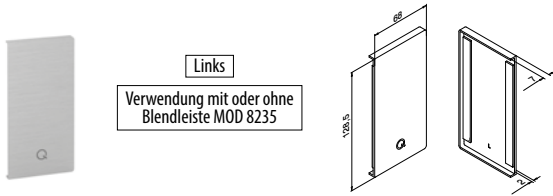

**MOD 8232**

<b>Aluminium</b>	Roh	<b>3M Klebeband</b>	
168232-01-00		Beigelegt	1
<b>Aluminium</b>	Gebürstet	<b>3M Klebeband</b>	
<b>OUTDOOR</b>		Angebracht	1

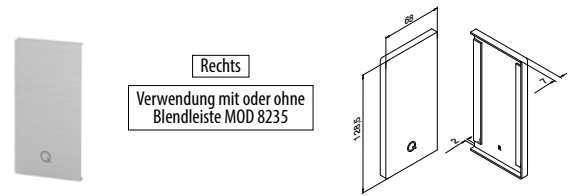

**MOD 8232**

<b>Aluminium</b>	Roh	<b>3M Klebeband</b>	
168232-02-00		Beigelegt	1
<b>Aluminium</b>	Gebürstet	<b>3M Klebeband</b>	
<b>OUTDOOR</b>		Angebracht	1

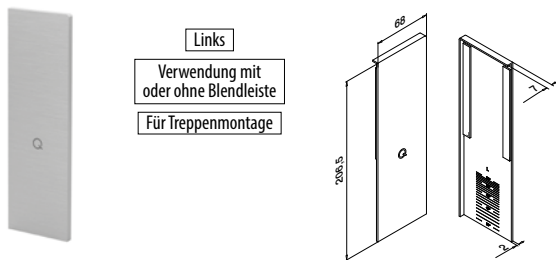

**MOD 8233**

<b>Aluminium</b>	Roh	<b>3M Klebeband</b>	
168233-01-00		Beigelegt	1
<b>Aluminium</b>	Gebürstet	<b>3M Klebeband</b>	
<b>OUTDOOR</b>		Angebracht	1

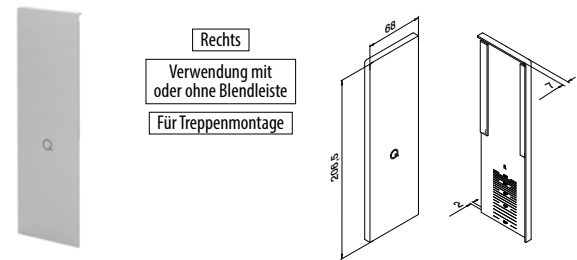

**MOD 8233**

<b>Aluminium</b>	Roh	<b>3M Klebeband</b>	
168233-02-00		Beigelegt	1
<b>Aluminium</b>	Gebürstet	<b>3M Klebeband</b>	
<b>OUTDOOR</b>		Angebracht	1



**Q-INFO** MOD 8232 / 8235

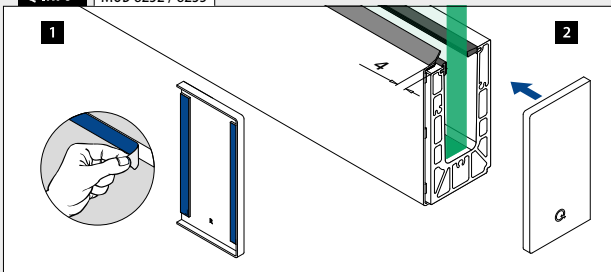

**Q-INFO** MOD 8233

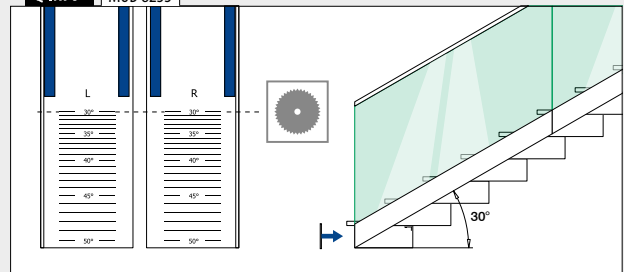

Geländerbasis

## Drainageleisten zur Seitenmontage

4 Stück für 2,5-Meter-Bodenprofil  
8 Stück für 5-Meter-Bodenprofil

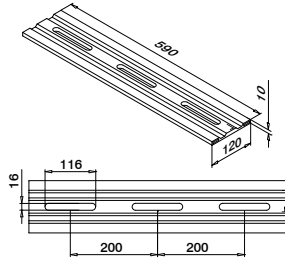

### MOD 8237

Aluminium Gebürstet  
OUTDOOR

168237-18



4

Geländerbasis

## Unterlegscheiben zur Seitenmontage

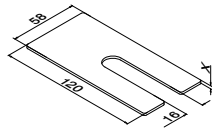

### MOD 8236

Aluminium Roh

	X	
168236-001	1	100
168236-002	2	100
168236-003	3	100

**Q-INFO** MOD 8237

Montage-  
informationen:

q-ne.ws/  
3mjLRW2

**Q-INFO** MOD 8236

**Q-INFO** Aluminium MOD 8234 / 8235



Roh



Gebürstet, anodisiert

Blendleisten zur Seitenmontage

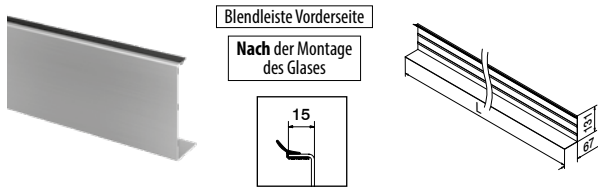

MOD 8235

<b>Aluminium</b>	Roh	<b>3M Klebeband</b>	
SELL OUT 168235-050-00		Nicht inkl.*	L = 5000 mm
<b>Aluminium</b>	Gebürstet	<b>3M Klebeband</b>	
<b>OUTDOOR</b>		Angebracht	L = 5000 mm
SELL OUT 168235-050-18			



\*Bestellen Sie MOD 1360 (3M Klebeband)

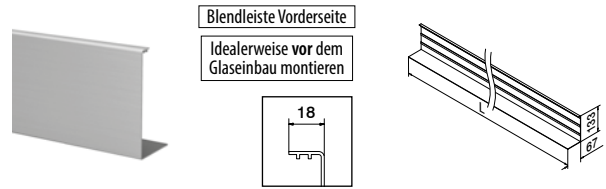

MOD 8234

<b>Aluminium</b>	Roh	<b>3M Klebeband</b>	
168234-050-00		Nicht inkl.*	L = 5000 mm
<b>Aluminium</b>	Gebürstet	<b>3M Klebeband</b>	
<b>OUTDOOR</b>		Angebracht	L = 5000 mm
168234-050-18			



\*Bestellen Sie MOD 1360 (3M Klebeband)

Blendstopfen zur Seitenmontage

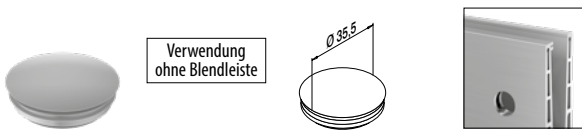

MOD 8238

<b>ABS Kunststoff</b>	Aluminium RAL 9006	
<b>OUTDOOR</b>		
158238-36		10

3M Acrylat-Klebeband



MOD 1360

<b>Zubehör</b>	<b>Q</b>	<b>W</b>	<b>L</b>	
201360	Q-53	9	33 m (für 11 m Blendleiste)	1

Q-INFO MOD 8234-050-00 / 1360

Montage-Informationen:



q-ne.ws/  
3yAb78x

Q-INFO MOD 8235-050-00 / 1360

Montage-Informationen:



q-ne.ws/  
3hUPp5



Nur solange der Vorrat reicht.

Q-INFO MOD 8234

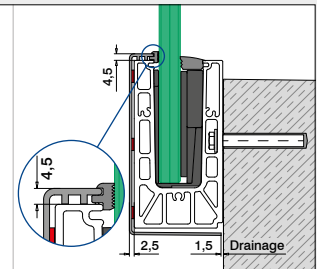
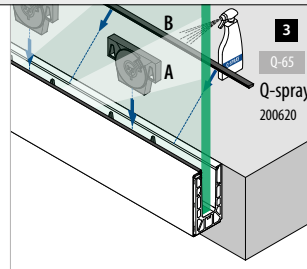
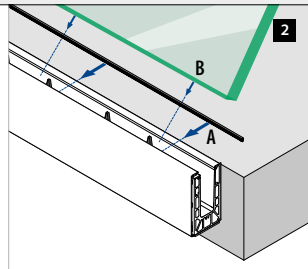
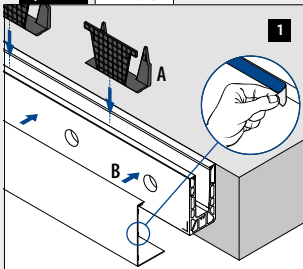

Q-INFO MOD 8235

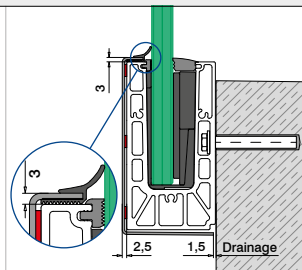
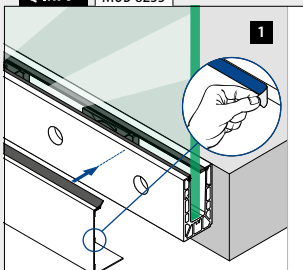

Q-INFO MOD 8238

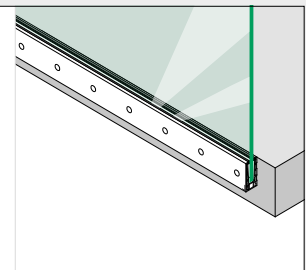
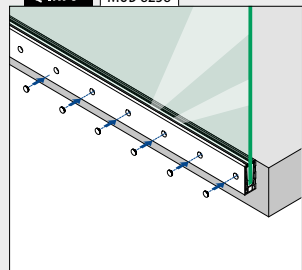

Geländerbasis

Bodenprofile zur Seitenmontage

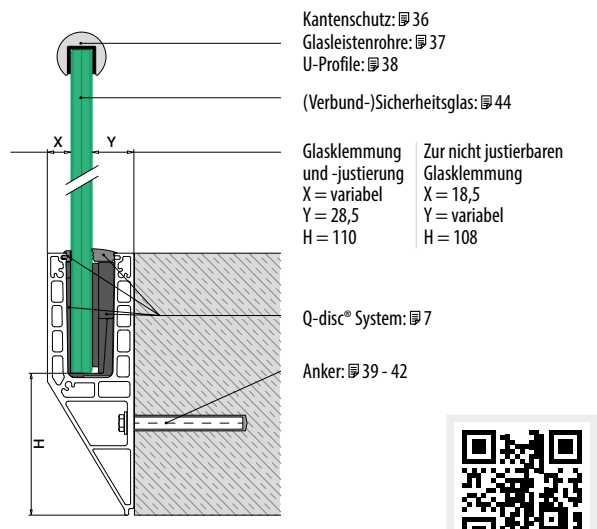

Montage-  
 informationen:  
[q-ne.ws/3wDkp18](http://q-ne.ws/3wDkp18)

Bitte beachten Sie die Spezifikationen wie Befestigungs- und Glasmaße sowie Glastypeen der jeweiligen Zertifikate.

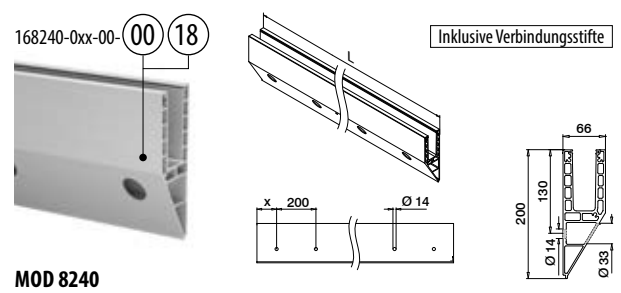

MOD 8240

Aluminium	Roh	X		
168240-050-00-00	100	39 - 42	L = 5000 mm	
Aluminium	Gebürstet	X		
168240-025-00-18	50	39 - 42	L = 2500 mm	
168240-050-00-18	100	39 - 42	L = 5000 mm	



Internationaler  
 Geschmacksmusterschutz

Geländerbasis

Ecken zur Seitenmontage

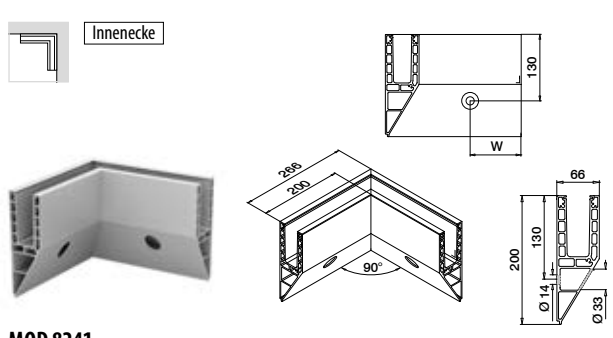

MOD 8241

Aluminium	Gebürstet	W		
168241-01-18	100*	39 - 42	1	



Internationaler Geschmacksmusterschutz

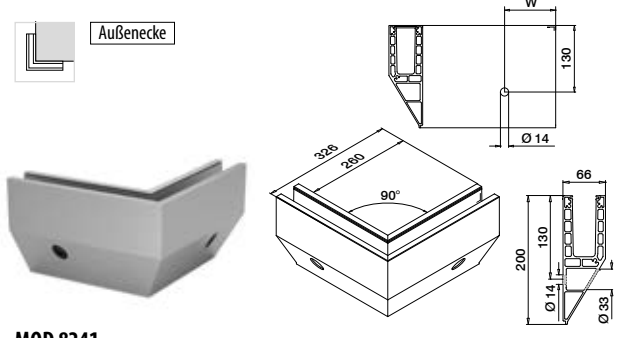

MOD 8241

Aluminium	Gebürstet	W		
168241-02-18	100*	39 - 42	1	



Internationaler Geschmacksmusterschutz

\*Die Lochposition kann produktionsbedingt um 25 mm abweichen.

Q-INFO

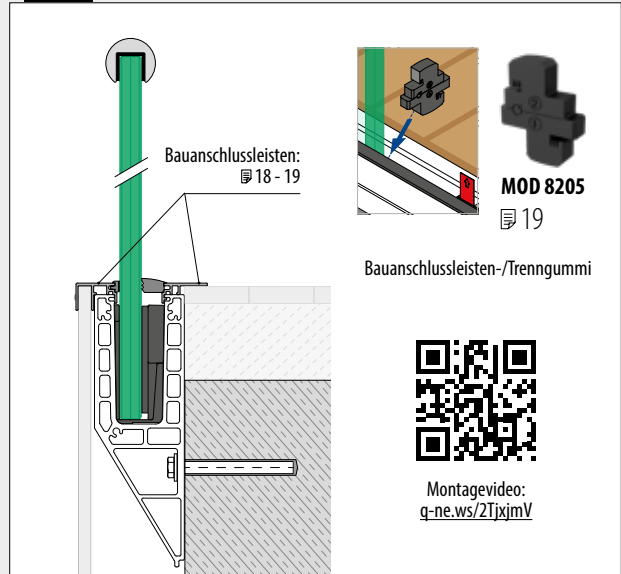

Q-INFO

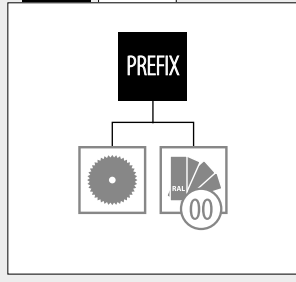

Q-INFO

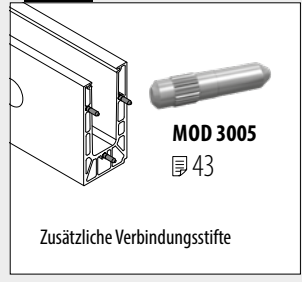

Q-INFO





## Endkappen zur Seitenmontage



Links  
Verwendung  
ohne Blendleiste

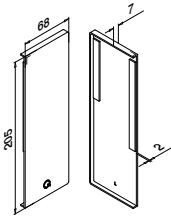

## MOD 8242

<b>Aluminium</b>	Roh	<b>3M Klebeband</b>	
168242-01-00	Beigelegt	1	
<b>Aluminium</b>	Gebürstet	<b>3M Klebeband</b>	
168242-01-18	Angebracht	1	



Rechts  
Verwendung  
ohne Blendleiste

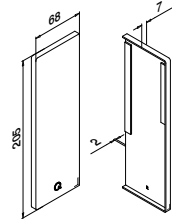

## MOD 8242

<b>Aluminium</b>	Roh	<b>3M Klebeband</b>	
168242-02-00	Beigelegt	1	
<b>Aluminium</b>	Gebürstet	<b>3M Klebeband</b>	
168242-02-18	Angebracht	1	



Links  
Verwendung mit  
oder ohne Blendleiste  
Für Treppmontage

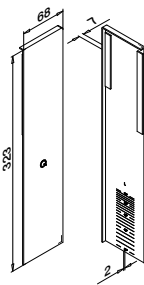

## MOD 8243

<b>Aluminium</b>	Gebürstet	<b>3M Klebeband</b>	
168243-01-18	Angebracht	1	



Rechts  
Verwendung mit  
oder ohne Blendleiste  
Für Treppmontage

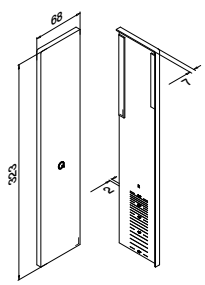

## MOD 8243

<b>Aluminium</b>	Gebürstet	<b>3M Klebeband</b>	
168243-02-18	Angebracht	1	



## Blendleisten zur Seitenmontage



Blendleiste Vorderseite  
Idealerweise vor dem  
Glaseinbau montieren

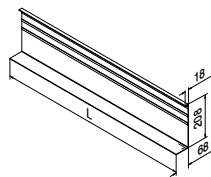

## MOD 8245

<b>Aluminium</b>	Roh	<b>3M Klebeband</b>	
168245-050-00	Nicht inkl.*	L = 5000 mm	
<b>Aluminium</b>	Gebürstet	<b>3M Klebeband</b>	
168245-050-18	Angebracht	L = 5000 mm	



\*Bestellen Sie MOD 1360 (3M Klebeband)

## 3M Acrylat-Klebeband



## MOD 1360

<b>Zubehör</b>	<b>Q</b>	<b>W</b>	<b>L</b>	
201360	Q-53	9	33 m (für 11 m Blendleiste)	1

## Q-INFO MOD 8243

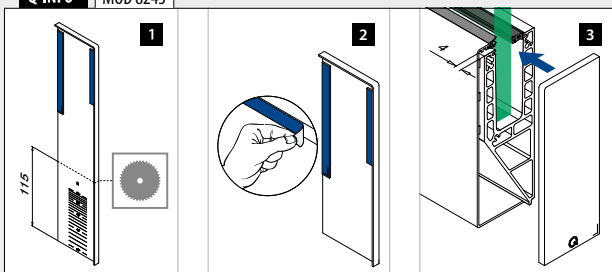

## Q-INFO MOD 8245-050-00 / 1360



## Q-INFO MOD 8245

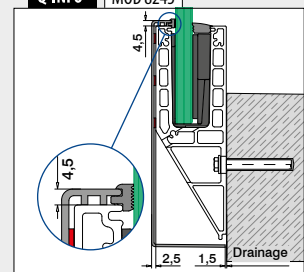



Bauanschlussleisten zur Seitenmontage

Für alle Smart-Profile

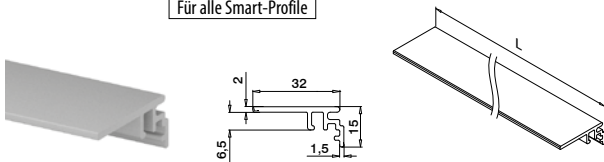

MOD 6973

<b>Aluminium</b>	Roh	
166973-50-00	L = 5000 mm	
<b>Aluminium</b>	Gebürstet	
<b>OUTDOOR</b>	L = 5000 mm	

Für Smart Seitenmontage- und Y-Profile

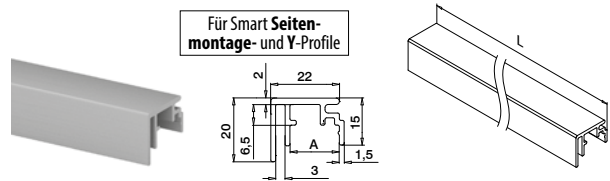

MOD 6970

<b>Aluminium</b>	Roh	
	A	
166970-003-50-00	15,5	L = 5000 mm
<b>Aluminium</b>	Gebürstet	
<b>OUTDOOR</b>	A	
166970-003-50-18	15,5	L = 5000 mm

Für Smart Seitenmontage- und Y-Profile

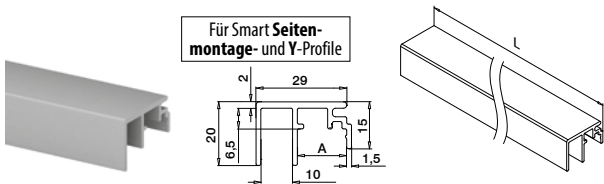

MOD 6970

<b>Aluminium</b>	Roh	
	A	
166970-010-50-00	15,5	L = 5000 mm
<b>Aluminium</b>	Gebürstet	
<b>OUTDOOR</b>	A	
166970-010-50-18	15,5	L = 5000 mm

Für Smart Seitenmontage- und Y-Profile

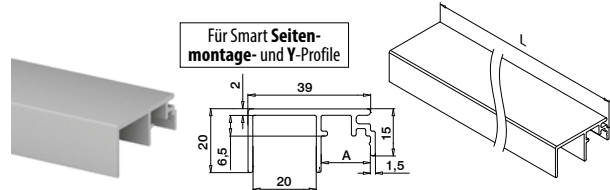

MOD 6970

<b>Aluminium</b>	Roh	
	A	
166970-020-50-00	15,5	L = 5000 mm
<b>Aluminium</b>	Gebürstet	
<b>OUTDOOR</b>	A	
166970-020-50-18	15,5	L = 5000 mm

Bauanschlussleisten-/Trenngummi



MOD 8205

<b>Zubehör</b>	
208205-010	5



Q-INFO MOD 6970 / 6972 / 6973

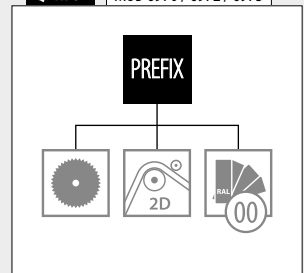

Q-INFO Aluminium

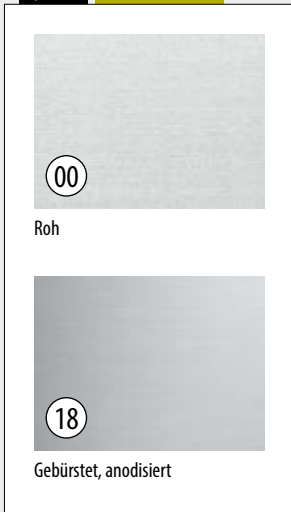

Q-INFO MOD 6972 / 6973

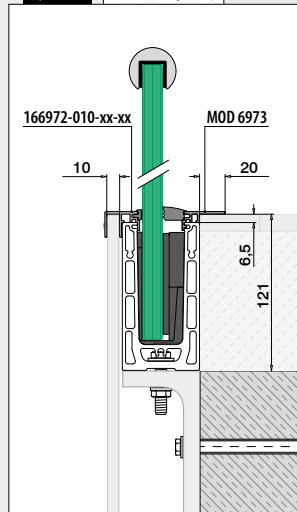

Q-INFO MOD 6970 / 6973

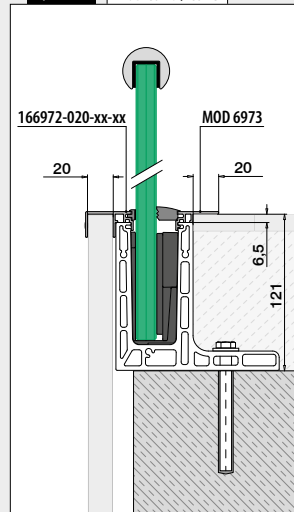

Q-INFO MOD 6970 / 6973

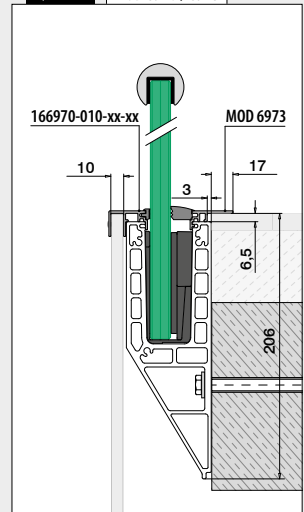

# EASY GLASS® PRIME

## MIT JUSTIERBAREM Q-DISC® SYSTEM

### Prime Bodenmontage

- Symmetrisches Bodenprofil
- Auch für die In-Bodenmontage

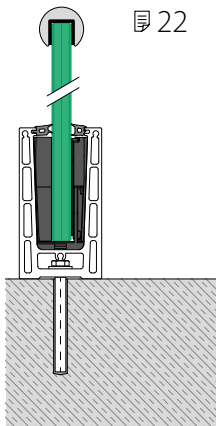

### Prime F Bodenmontage

- Für Rohfußböden
- Kann direkt an oder über der Bodenkante angebracht werden

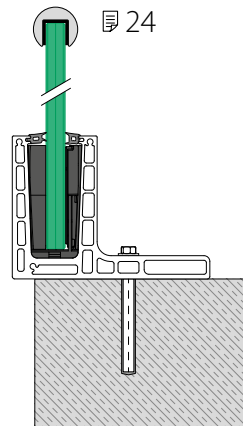

### Prime Seitenmontage

- Auch zur Montage an der Innenseite von Aufmauerungen
- Bodenprofil-Blendleiste erhältlich

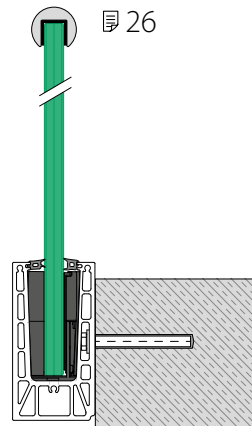

### Prime Y Seitenmontage

- Für Rohfußböden
- Kann direkt an oder über der Bodenkante angebracht werden
- Bodenprofil-Blendleiste erhältlich

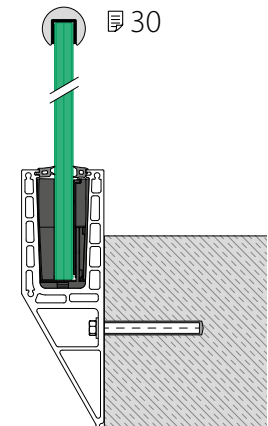

- 1 Richten Sie die Glasscheiben um bis zu 1,2° in der Vertikalen aus.
- 2 Durch Markierungen und ein Klickgeräusch signalisiert die Q-disc die korrekte Montage.
- 3 Geeignet für Glasstärken zwischen 16,76 und 25,52 mm.

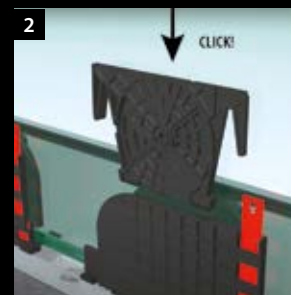

### EINFACHE MONTAGE: BODENUNEVENHEITEN MIT UNTERLEGSCHLEIBEN AUSGLEICHEN

☞ 23, 28

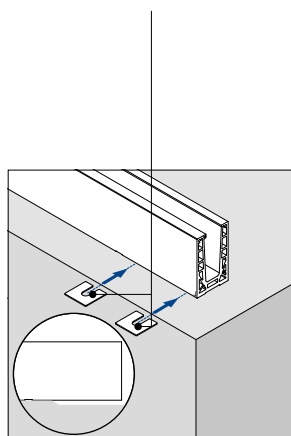

Füllung  
☞ 44



Glas

Glasabschluss und  
Handlauf  
☞ 36 - 38



Kantenschutz



Glasleistenrohre



U-Profile

Beleuchtung  
Siehe Produktkatalog  
☞ 164 - 187



Spotlight



Linear Light

Prefix  
☞ 46



Zuschnitte



Pulverbeschichtung



2D-Biegen

Extras



Bauanschlussleisten  
☞ 34-35



Unterlegscheiben  
☞ 23, 28



Drainageleisten  
☞ 23, 28



Blendleisten  
☞ 29, 32

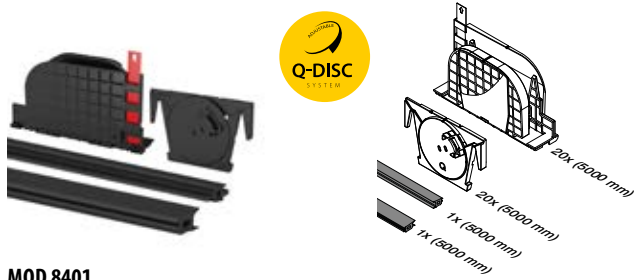

## MOD 8401

## Zubehör

Mono.	T	
208401-050-19	19	L = 5000 mm

Lam.	T	
208401-050-17	16,76 (8-0,76-8)	L = 5000 mm
208401-050-18	17,52 (8-1,52-8)	L = 5000 mm
208401-050-21	20,76 (10-0,76-10)	L = 5000 mm
208401-050-22	21,52 (10-1,52-10)	L = 5000 mm
208401-050-24	24,76 (12-0,76-12)	L = 5000 mm
208401-050-26	25,52 (12-1,52-12)	L = 5000 mm

208401-250-17	16,76 (8-0,76-8)	L = 25 m
208401-250-18	17,52 (8-1,52-8)	L = 25 m
208401-250-21	20,76 (10-0,76-10)	L = 25 m
208401-250-22	21,52 (10-1,52-10)	L = 25 m
208401-250-24	24,76 (12-0,76-12)	L = 25 m
208401-250-26	25,52 (12-1,52-12)	L = 25 m



reddot winner 2020

Internationaler Geschmacksmusterschutz



## MOD 1000

## Zubehör

	Q	
201000	Q-84	1

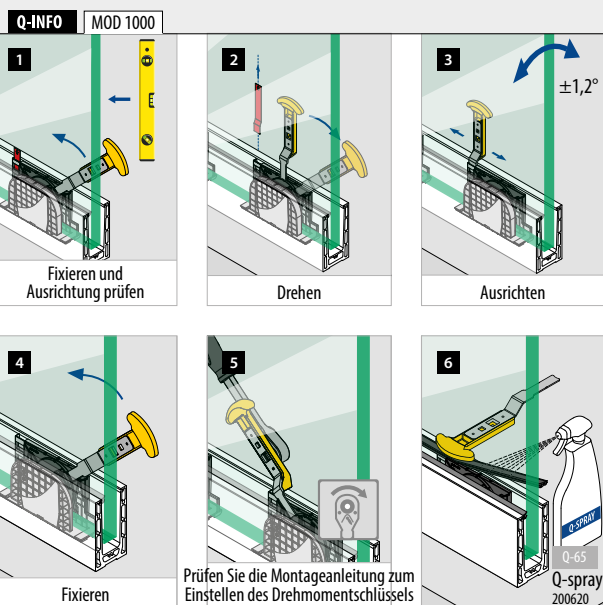

Geländerbasis

### Bodenprofile zur Bodenmontage

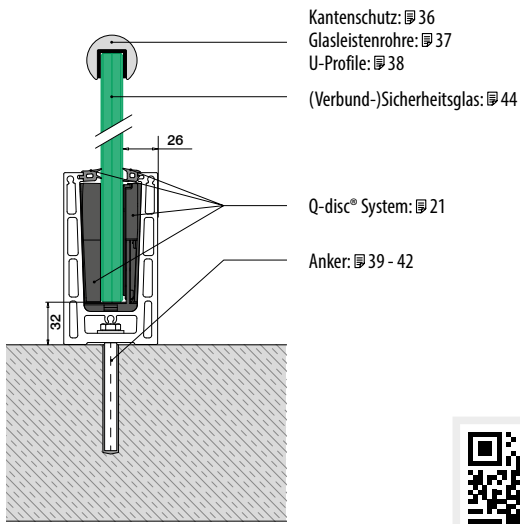

Kantenschutz: 36  
 Glasleistenrohre: 37  
 U-Profil: 38  
 (Verbund-)Sicherheitsglas: 44  
 Q-disc® System: 21  
 Anker: 39 - 42



Montage-  
 informationen:  
[q-ne.ws/3vtV9uH](http://q-ne.ws/3vtV9uH)

Bitte beachten Sie die Spezifikationen wie Befestigungs- und Glasmaße sowie Glastypen der jeweiligen Zertifikate.

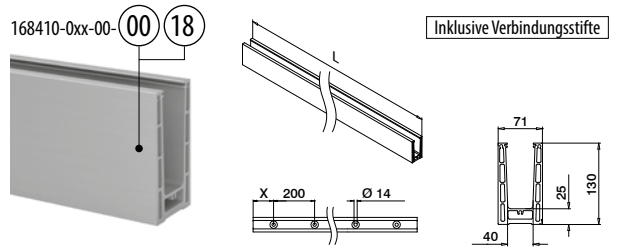

#### MOD 8410

Aluminium	Roh		
	X		
168410-050-00-00	100	39 - 42	L = 5000 mm
Aluminium	Gebürstet		
	OUTDOOR X		
168410-025-00-18	50	39 - 42	L = 2500 mm
168410-050-00-18	100	39 - 42	L = 5000 mm



Internationaler  
 Geschmacksmusterschutz

Geländerbasis

### Ecken zur Bodenmontage

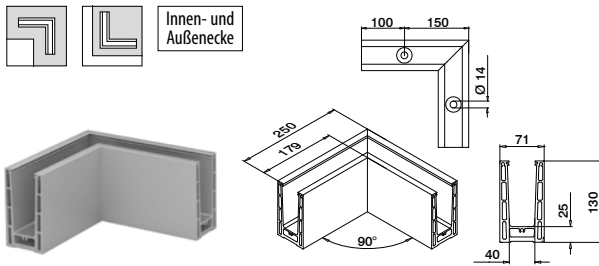

#### MOD 8411

Aluminium	Roh		
	X		
168411-00-00		39 - 42	1
Aluminium	Gebürstet		
	OUTDOOR		
168411-00-18		39 - 42	1



Q-INFO MOD 8410

Montagevideo:  
[q-ne.ws/3fRjm7p](http://q-ne.ws/3fRjm7p)

Q-INFO MOD 8410

PREFIX

Q-INFO

MOD 3005  
 43  
 Zusätzliche Verbindungsstifte

Q-INFO Aluminium

Roh  
 Gebürstet, anodisiert

## Endkappen zur Bodenmontage

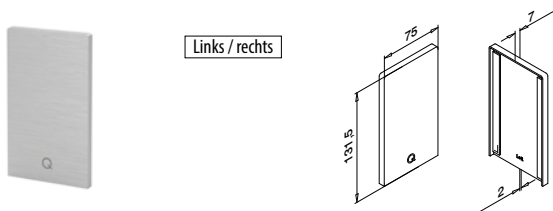

## MOD 8412

<b>Aluminium</b>	Roh		
		<b>3M Klebeband</b>	
168412-00-00	Beigelegt		1
<b>Aluminium</b>	Gebürstet		
<b>OUTDOOR</b>		<b>3M Klebeband</b>	
168412-00-18	Angebracht		1

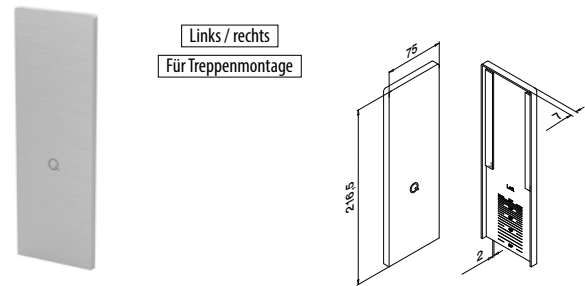

## MOD 8413

<b>Aluminium</b>	Roh		
		<b>3M Klebeband</b>	
168413-00-00	Beigelegt		1
<b>Aluminium</b>	Gebürstet		
<b>OUTDOOR</b>		<b>3M Klebeband</b>	
168413-00-18	Angebracht		1



## Unterlegscheiben zur Bodenmontage

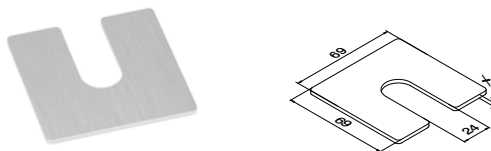

## MOD 8416

<b>Aluminium</b>	Roh		
		<b>X</b>	
168416-001	1		100
168416-002	2		100
168416-003	3		100

## Drainageleisten zur Bodenmontage

4 Stück für 2,5-Meter-Bodenprofil  
8 Stück für 5-Meter-Bodenprofil

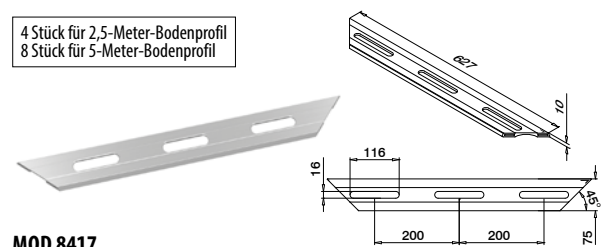

## MOD 8417

<b>Aluminium</b>	Gebürstet		
		<b>OUTDOOR</b>	
168417-18			4

## Q-INFO MOD 8416

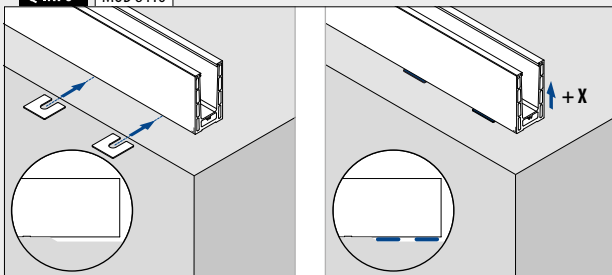

## Q-INFO MOD 8412

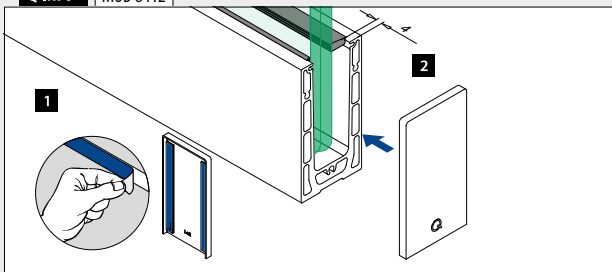

## Q-INFO MOD 8417

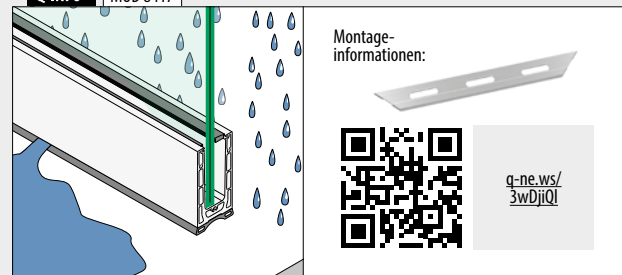

## Q-INFO MOD 8413

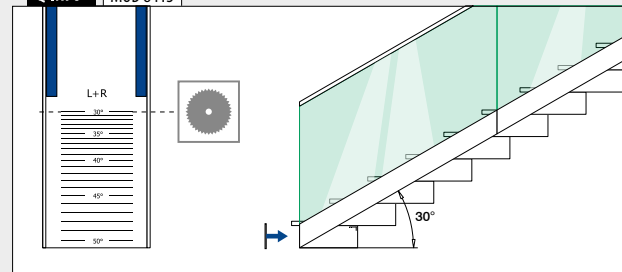

Geländerbasis

Bodenprofile zur Bodenmontage

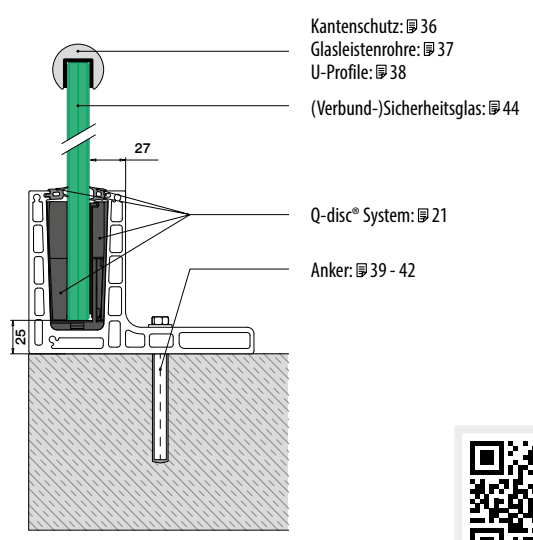

- Kantenschutz: 36
- Glasleistenrohre: 37
- U-Profile: 38
- (Verbund-)Sicherheitsglas: 44
- Q-disc® System: 21
- Anker: 39 - 42



Montage-  
informationen:  
[q-ne.ws/3vtV9uH](http://q-ne.ws/3vtV9uH)

Bitte beachten Sie die Spezifikationen wie Befestigungs- und Glasmaße sowie Glastypeen der jeweiligen Zertifikate.

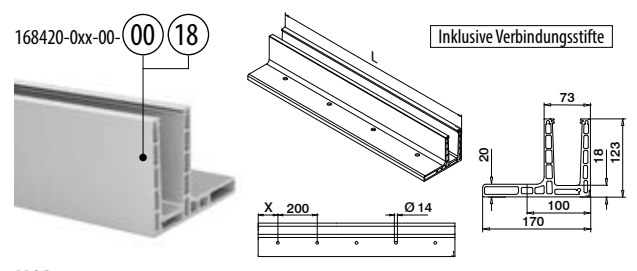

MOD 8420

Aluminium	Roh	X		
168420-050-00-00	100	39 - 42	L = 5000 mm	
Aluminium	Gebürstet	X		
168420-025-00-18	50	39 - 42	L = 2500 mm	
168420-050-00-18	100	39 - 42	L = 5000 mm	



Internationaler  
Geschmacksmusterschutz

Geländerbasis

Ecken zur Bodenmontage

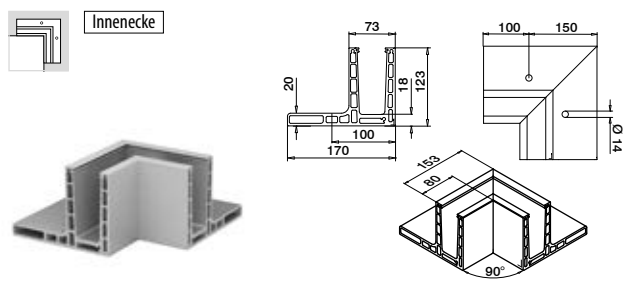

MOD 8421

Aluminium	Gebürstet	X		
168421-01-18	OUTDOOR	39 - 42	1	

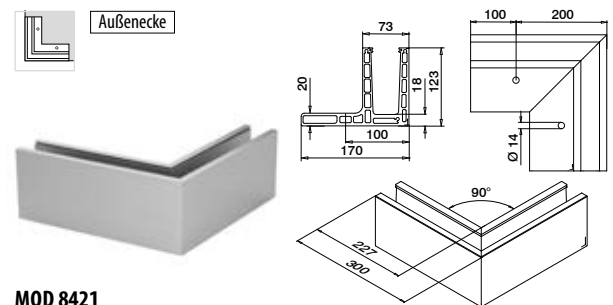

MOD 8421

Aluminium	Gebürstet	X		
168421-02-18	OUTDOOR	39 - 42	1	



Q-INFO MOD 8420

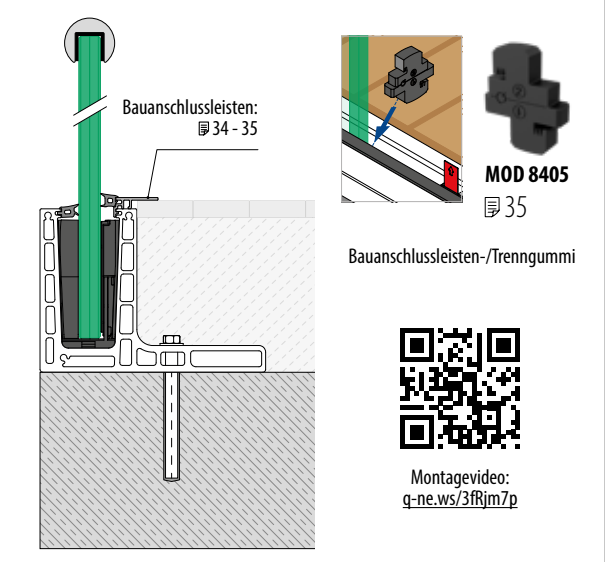

Q-INFO MOD 8420

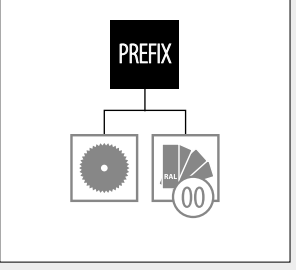

Q-INFO

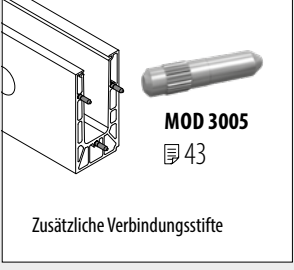

Q-INFO Aluminium MOD 8420

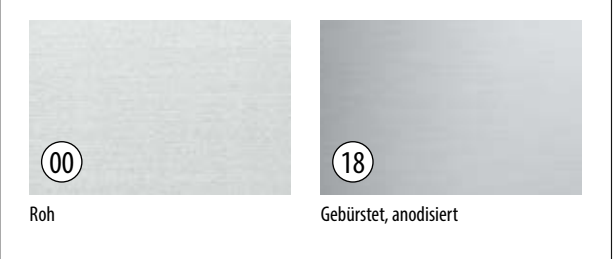



## Endkappen zur Bodenmontage

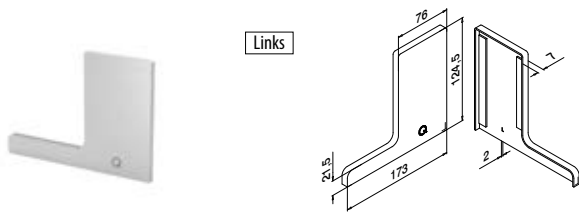

## MOD 8422

<b>Aluminium</b>	Roh		
	<b>3M Klebeband</b>		
168422-01-00	Beigelegt	1	
<b>Aluminium</b>	Gebürstet		
<b>OUTDOOR</b>	<b>3M Klebeband</b>		
168422-01-18	Angebracht	1	

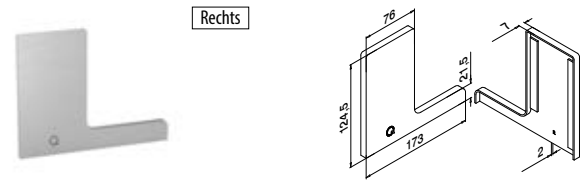

## MOD 8422

<b>Aluminium</b>	Roh		
	<b>3M Klebeband</b>		
168422-02-00	Beigelegt	1	
<b>Aluminium</b>	Gebürstet		
<b>OUTDOOR</b>	<b>3M Klebeband</b>		
168422-02-18	Angebracht	1	

## Q-INFO

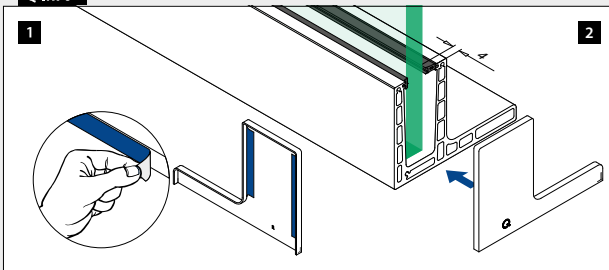

Geländerbasis

Bodenprofile zur Seitenmontage

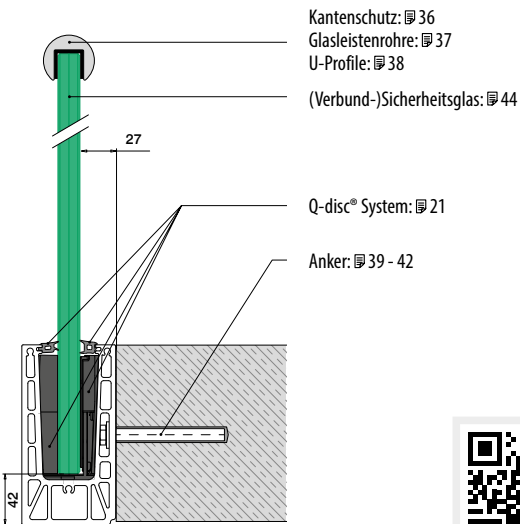

Kantenschutz: 36  
 Glasleistenrohre: 37  
 U-Profile: 38  
 (Verbund-)Sicherheitsglas: 44  
 Q-disc® System: 21  
 Anker: 39 - 42



Montage-  
 informationen:  
[q-ne.ws/3vtV9uH](http://q-ne.ws/3vtV9uH)

Bitte beachten Sie die Spezifikationen wie Befestigungs- und Glasmaße sowie Glastypeen der jeweiligen Zertifikate.

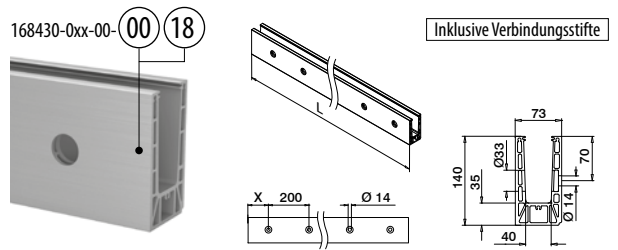

MOD 8430

Aluminium	Roh		
	X		
168430-050-00-00	100	39 - 42	L = 5000 mm
Aluminium	Gebürstet		
	OUTDOOR X		
168430-025-00-18	50	39 - 42	L = 2500 mm
168430-050-00-18	100	39 - 42	L = 5000 mm



Internationaler  
 Geschmacksmusterschutz

Geländerbasis

Ecken zur Seitenmontage

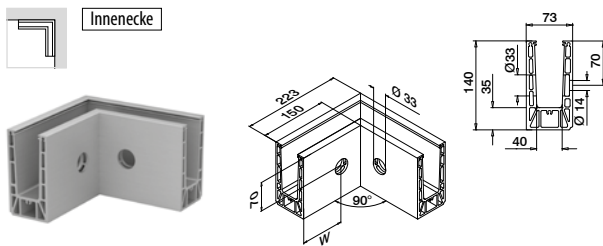

MOD 8431

Aluminium	Roh		
	W		
168431-01-00	100*	39 - 42	1
Aluminium	Gebürstet		
	OUTDOOR W		
168431-01-18	100*	39 - 42	1

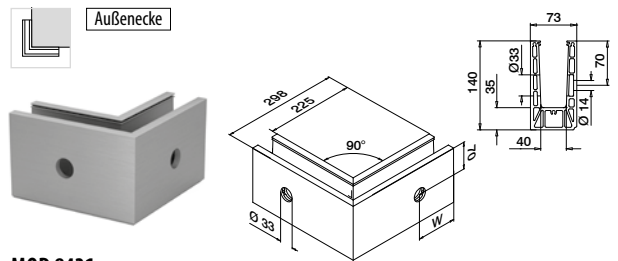

MOD 8431

Aluminium	Roh		
	W		
168431-02-00	100*	39 - 42	1
Aluminium	Gebürstet		
	OUTDOOR W		
168431-02-18	100*	39 - 42	1



\*Die Lochposition kann produktionsbedingt um 25 mm abweichen.

Q-INFO MOD 8430

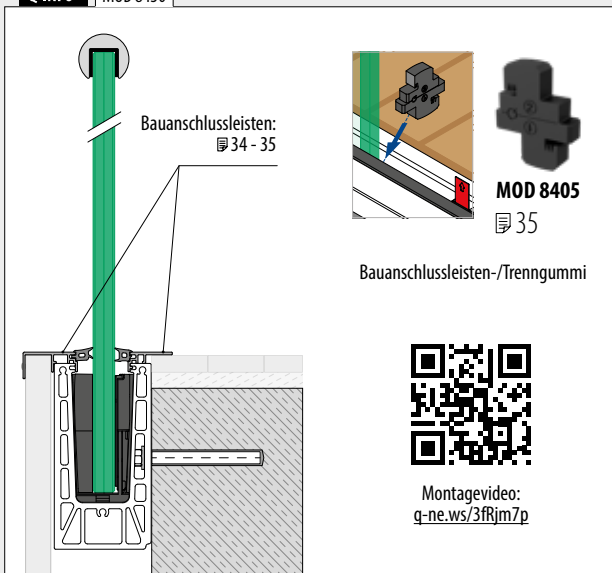

Q-INFO MOD 8430

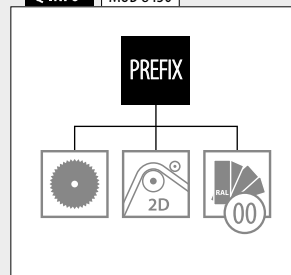

Q-INFO



Q-INFO Aluminium



Endkappen zur Seitenmontage

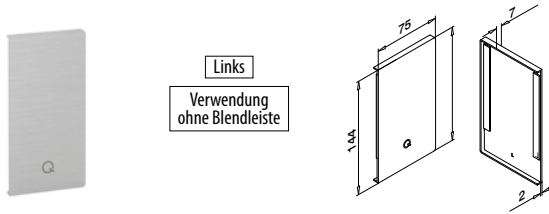

**MOD 8432**

<b>Aluminium</b>	Roh	<b>3M Klebeband</b>	
168432-01-00	Beigelegt		1
<b>Aluminium</b>	Gebürstet	<b>3M Klebeband</b>	
<b>OUTDOOR</b>		<b>3M Klebeband</b>	
168432-01-18	Angebracht		1

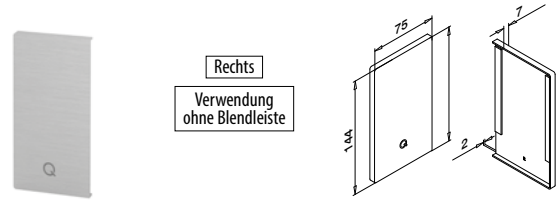

**MOD 8432**

<b>Aluminium</b>	Roh	<b>3M Klebeband</b>	
168432-02-00	Beigelegt		1
<b>Aluminium</b>	Gebürstet	<b>3M Klebeband</b>	
<b>OUTDOOR</b>		<b>3M Klebeband</b>	
168432-02-18	Angebracht		1

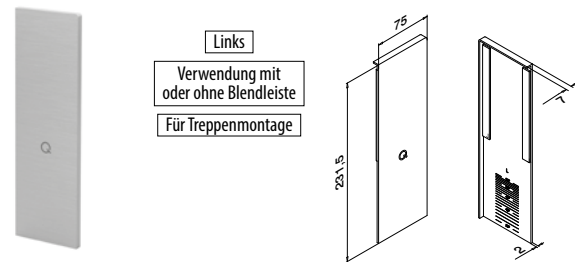

**MOD 8433**

<b>Aluminium</b>	Roh	<b>3M Klebeband</b>	
168433-01-00	Beigelegt		1
<b>Aluminium</b>	Gebürstet	<b>3M Klebeband</b>	
<b>OUTDOOR</b>		<b>3M Klebeband</b>	
168433-01-18	Angebracht		1

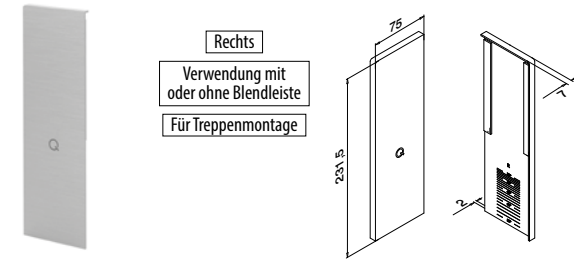

**MOD 8433**

<b>Aluminium</b>	Roh	<b>3M Klebeband</b>	
168433-02-00	Beigelegt		1
<b>Aluminium</b>	Gebürstet	<b>3M Klebeband</b>	
<b>OUTDOOR</b>		<b>3M Klebeband</b>	
168433-02-18	Angebracht		1

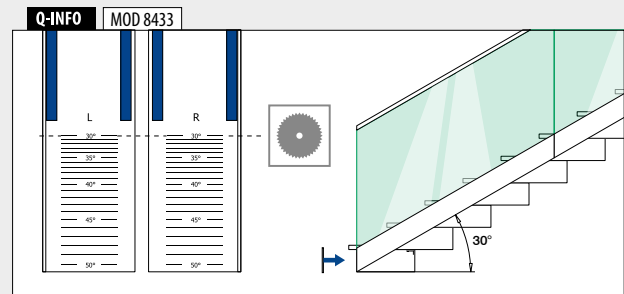
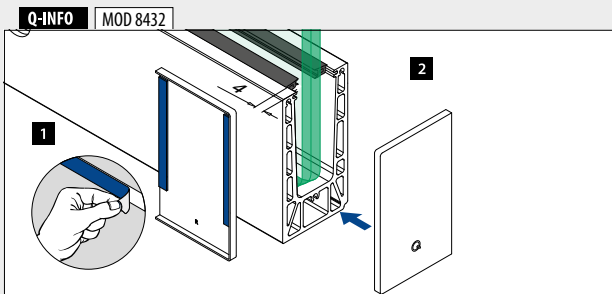

Geländerbasis

## Drainageleisten zur Seitenmontage

4 Stück für 2,5-Meter-Bodenprofil  
8 Stück für 5-Meter-Bodenprofil

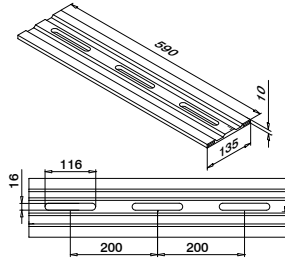

### MOD 8437

Aluminium Gebürstet

OUTDOOR



168437-18

4

Geländerbasis

## Unterlegscheiben zur Seitenmontage

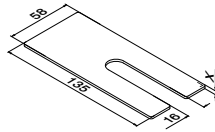

### MOD 8436

Aluminium Roh

X



168436-001

1

100

168436-002

2

100

168436-003

3

100

Q-INFO MOD 8437

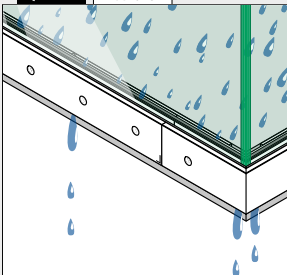

Montage-  
informationen:



q-ne.ws/  
3uAxM1t

Q-INFO MOD 8436

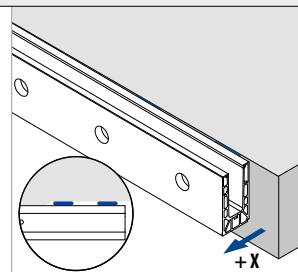
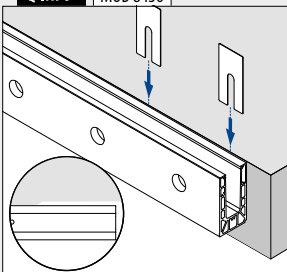

Q-INFO Aluminium MOD 8435

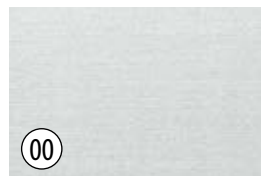

Roh



Gebürstet, anodisiert

## Blendleisten zur Seitenmontage



Blendleiste Vorderseite

Idealerweise vor dem Glaseinbau montieren

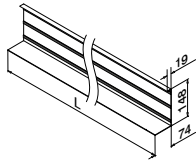

## MOD 8435

<b>Aluminium</b>	Roh	<b>3M Klebeband</b>	
168435-050-00	Nicht inkl.*	L = 5000 mm	
<b>Aluminium</b>	Gebürstet	<b>3M Klebeband</b>	
<b>OUTDOOR</b>	Angebracht	L = 5000 mm	
168435-050-18			



\*Bestellen Sie MOD 1360 (3M Klebeband)

## 3M Acrylat-Klebeband



## MOD 1360

<b>Zubehör</b>	<b>Q</b>	<b>W</b>	<b>L</b>	
201360	Q-53	9	33 m (für 11 m Blindleiste)	1

## Blendstopfen zur Seitenmontage



Verwendung ohne Blindleiste

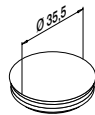

## MOD 8238

<b>ABS Kunststoff</b>	Aluminium RAL 9006	
<b>OUTDOOR</b>		
158238-36		10

## Q-INFO MOD 8238

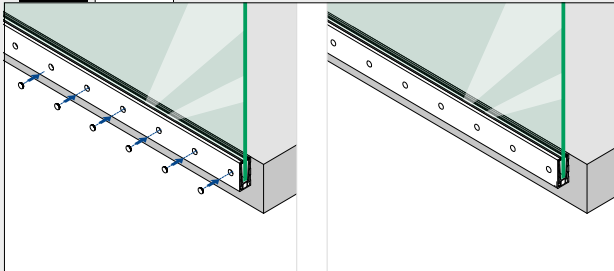

## Q-INFO MOD 8435-050-00 / 1360



## Q-INFO MOD 8435

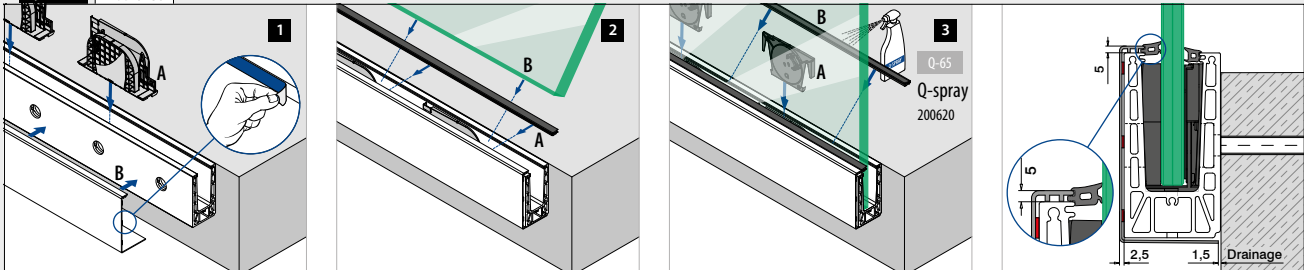

Geländerbasis

**Bodenprofile zur Seitenmontage**

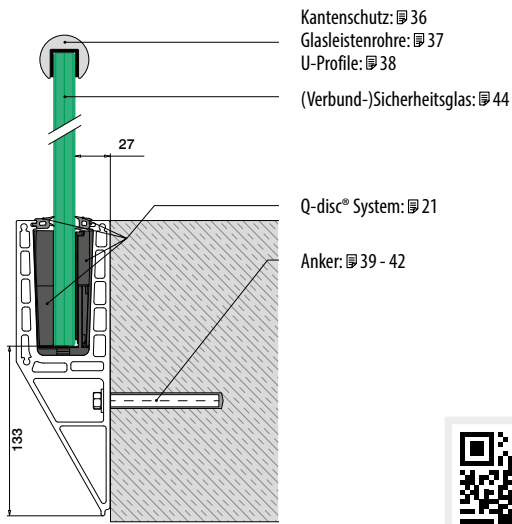

Montage-  
informationen:  
[q-ne.ws/3vtV9uH](http://q-ne.ws/3vtV9uH)

Bitte beachten Sie die Spezifikationen wie Befestigungs- und Glasmaße sowie Glastypen der jeweiligen Zertifikate.

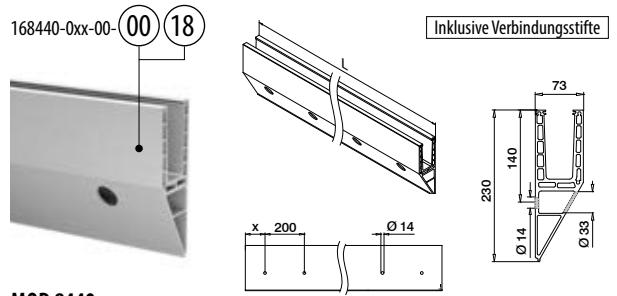

**MOD 8440**

Aluminium	Roh	X		
168440-050-00-00	100	39 - 42	L = 5000 mm	
Aluminium	Gebürstet	X		
168440-025-00-18	50	39 - 42	L = 2500 mm	
168440-050-00-18	100	39 - 42	L = 5000 mm	



Internationaler  
Geschmacksmusterschutz

Geländerbasis

**Ecken zur Seitenmontage**

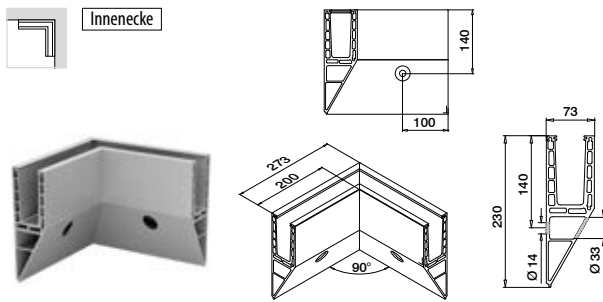

**MOD 8441**

Aluminium	Gebürstet	OUTDOOR		
168441-01-18	39 - 42		1	

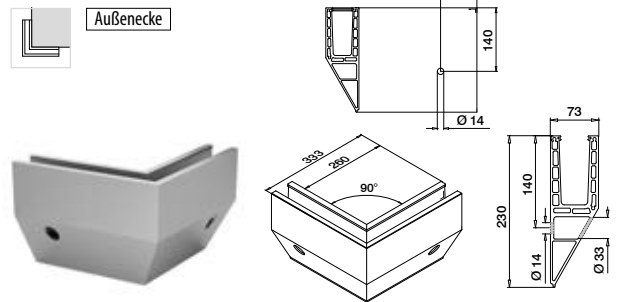

**MOD 8441**

Aluminium	Gebürstet	OUTDOOR		
168441-02-18	39 - 42		1	



Q-INFO MOD 8440

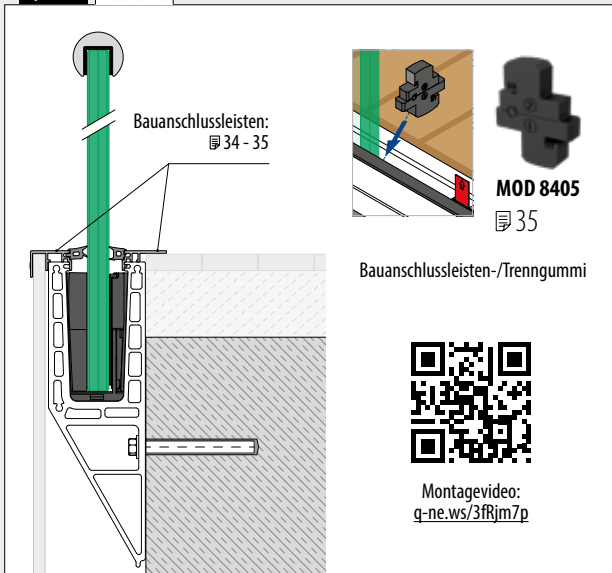

Q-INFO MOD 8440

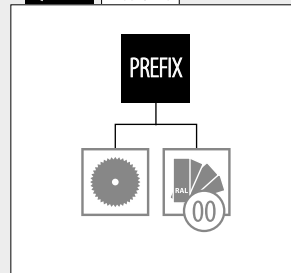

Q-INFO

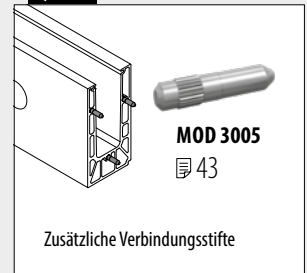

Q-INFO Aluminium MOD 8440



Endkappen zur Seitenmontage



Links  
Verwendung  
ohne Blendleiste

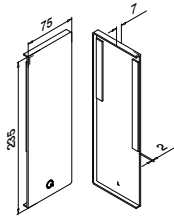

**MOD 8442**

<b>Aluminium</b>	Roh	<b>3M Klebeband</b>	
168442-01-00	Beigelegt	1	
<b>Aluminium</b>	Gebürstet	<b>3M Klebeband</b>	
168442-01-18	Angebracht	1	



Rechts  
Verwendung  
ohne Blendleiste

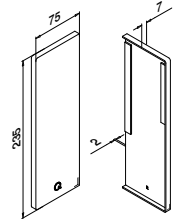

**MOD 8442**

<b>Aluminium</b>	Roh	<b>3M Klebeband</b>	
168442-02-00	Beigelegt	1	
<b>Aluminium</b>	Gebürstet	<b>3M Klebeband</b>	
168442-02-18	Angebracht	1	



Links  
Verwendung mit  
oder ohne Blendleiste  
Für Treppenmontage

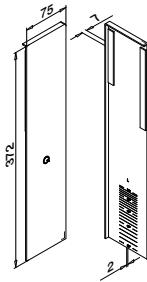

**MOD 8443**

<b>Aluminium</b>	Gebürstet	<b>3M Klebeband</b>	
168443-01-18	Angebracht	1	



Rechts  
Verwendung mit  
oder ohne Blendleiste  
Für Treppenmontage

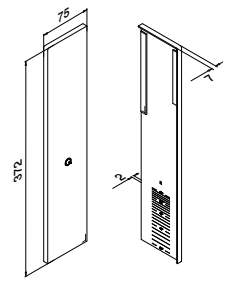

**MOD 8443**

<b>Aluminium</b>	Gebürstet	<b>3M Klebeband</b>	
168443-02-18	Angebracht	1	

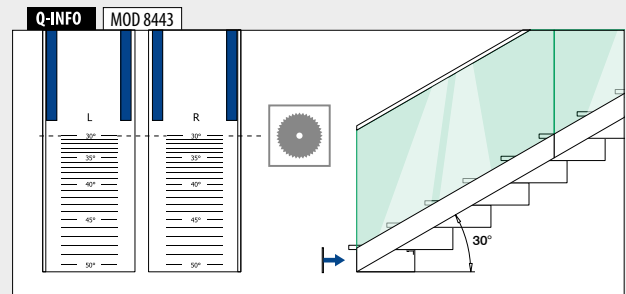
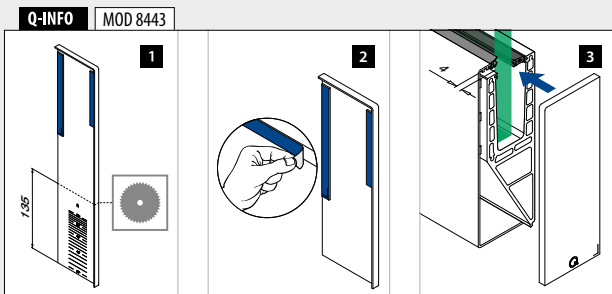

Geländerbasis

Blendleisten zur Seitenmontage



Blendleiste Vorderseite  
Idealerweise vor dem Glaseinbau montieren

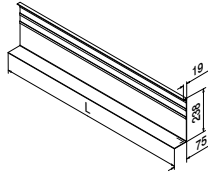

MOD 8455

<b>Aluminium</b>	Roh	<b>3M Klebeband</b>	
168455-050-00		Nicht inkl.*	L = 5000 mm
<b>Aluminium</b>	Gebürstet	<b>3M Klebeband</b>	
<b>OUTDOOR</b>		Angebracht	L = 5000 mm
168455-050-18			



\*Bestellen Sie MOD 1360 (3M Klebeband)

Zubehör

3M Acrylat-Klebeband



MOD 1360

<b>Zubehör</b>	<b>Q</b>	<b>W</b>	<b>L</b>	
201360	Q-53	9	33 m (für 11 m Blendleiste)	1

Q-INFO Aluminium MOD 8455



Q-INFO MOD 8455-050-00 / 1360



Q-INFO MOD 8455

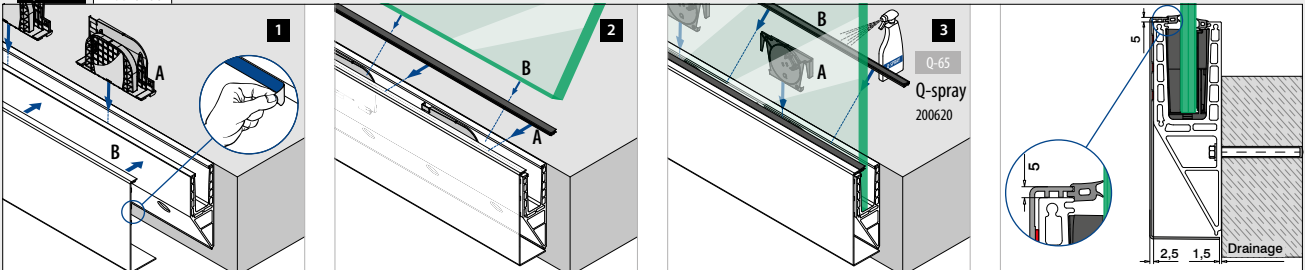





EASY GLASS® PRIME

Bauanschlussleisten

Für alle Prime-Profile

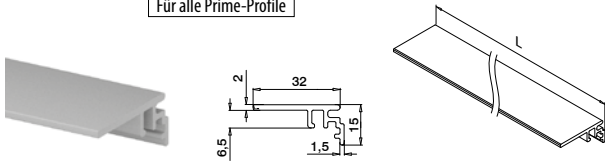

MOD 6973

<b>Aluminium</b>	Roh	
166973-50-00		L = 5000 mm
<b>Aluminium</b>	Gebürstet	
<b>OUTDOOR</b>		L = 5000 mm
166973-50-18		L = 5000 mm

Für Prime Bodenmontage-Profile

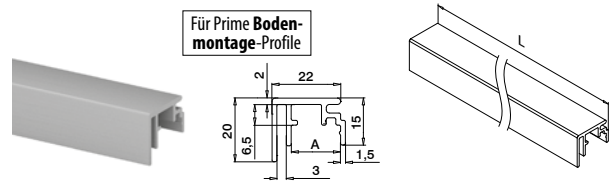

MOD 6970

<b>Aluminium</b>	Roh	
	A	L = 5000 mm
166970-003-50-00	15,5	L = 5000 mm
<b>Aluminium</b>	Gebürstet	
<b>OUTDOOR</b>	A	L = 5000 mm
166970-003-50-18	15,5	L = 5000 mm

Für Prime Bodenmontage-Profile

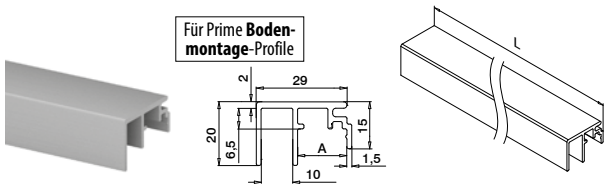

MOD 6970

<b>Aluminium</b>	Roh	
	A	L = 5000 mm
166970-010-50-00	15,5	L = 5000 mm
<b>Aluminium</b>	Gebürstet	
<b>OUTDOOR</b>	A	L = 5000 mm
166970-010-50-18	15,5	L = 5000 mm

Für Prime Bodenmontage-Profile

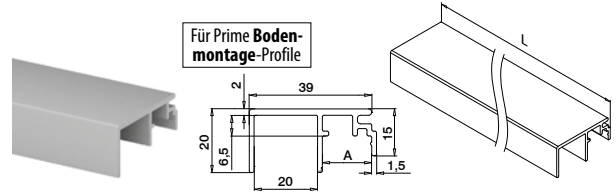

MOD 6970

<b>Aluminium</b>	Roh	
	A	L = 5000 mm
166970-020-50-00	15,5	L = 5000 mm
<b>Aluminium</b>	Gebürstet	
<b>OUTDOOR</b>	A	L = 5000 mm
166970-020-50-18	15,5	L = 5000 mm

Q-INFO

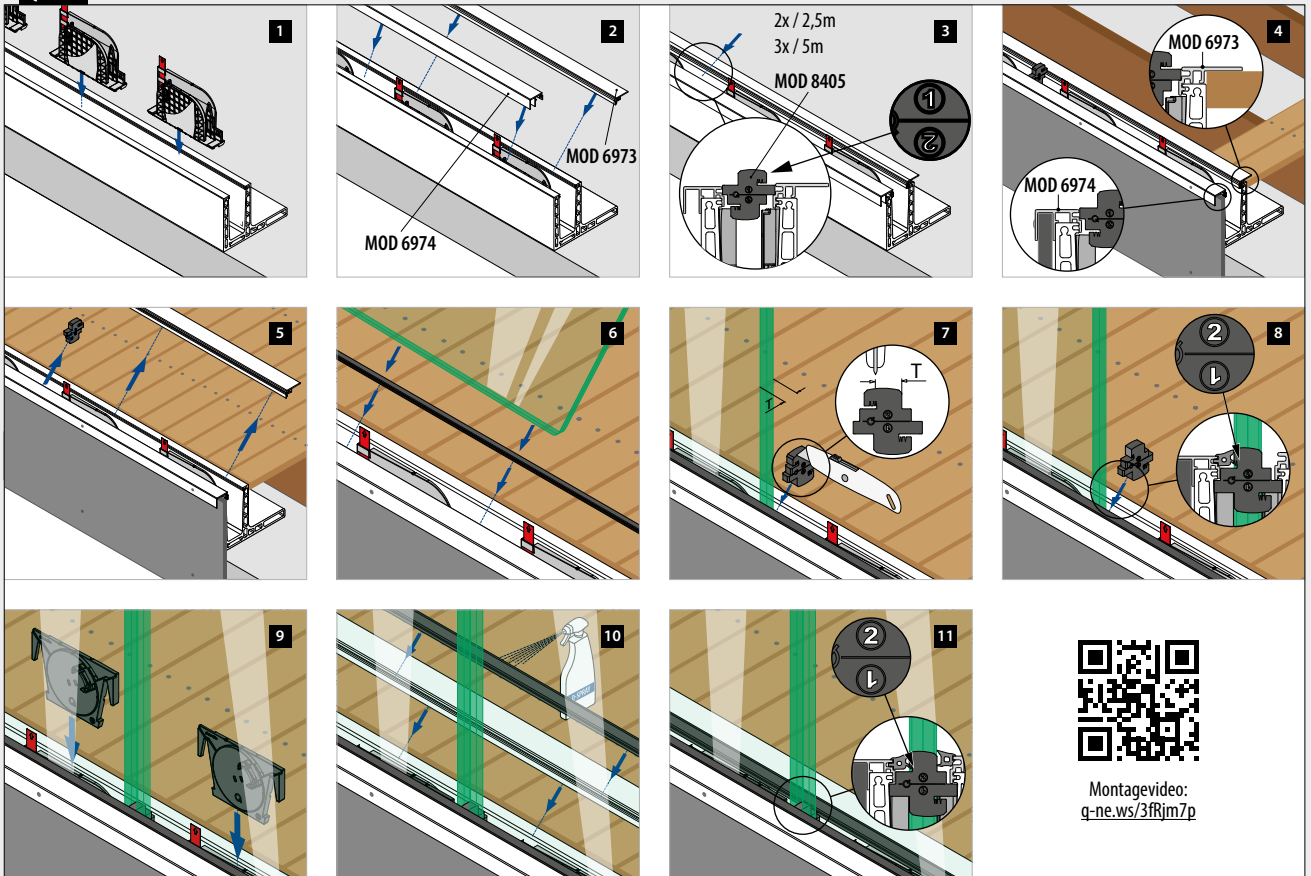

Montagevideo:  
q-ne.ws/3frjm7p

Bauanschlussleisten

Für alle Prime-Profile

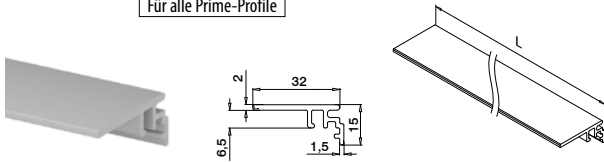

MOD 6973

<b>Aluminium</b>	Roh	
166973-50-00		L = 5000 mm
<b>Aluminium</b>	Gebürstet	
<b>OUTDOOR</b>		
166973-50-18		L = 5000 mm

Für Prime F-, Seitenmontage- und Y-Profile

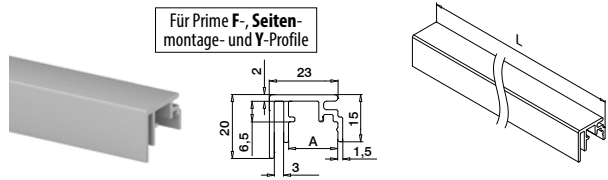

MOD 6974

<b>Aluminium</b>	Roh	
	A	
166974-003-50-00	16,5	L = 5000 mm
<b>Aluminium</b>	Gebürstet	
<b>OUTDOOR</b>	A	
166974-003-50-18	16,5	L = 5000 mm

Für Prime F-, Seitenmontage- und Y-Profile

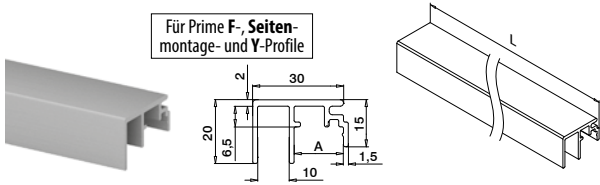

MOD 6974

<b>Aluminium</b>	Roh	
	A	
166974-010-50-00	16,5	L = 5000 mm
<b>Aluminium</b>	Gebürstet	
<b>OUTDOOR</b>	A	
166974-010-50-18	16,5	L = 5000 mm

Für Prime F-, Seitenmontage- und Y-Profile

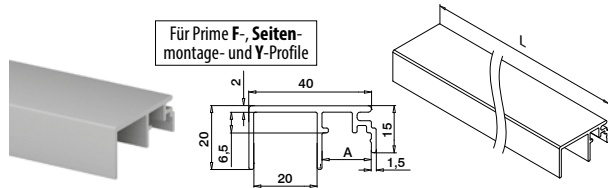

MOD 6974

<b>Aluminium</b>	Roh	
	A	
166974-020-50-00	16,5	L = 5000 mm
<b>Aluminium</b>	Gebürstet	
<b>OUTDOOR</b>	A	
166974-020-50-18	16,5	L = 5000 mm

Bauanschlussleisten-/Trenngummi

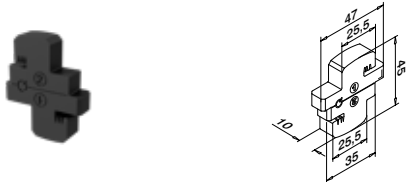

MOD 8405

<b>Zubehör</b>		
208405-010		5



Q-INFO MOD 6970 / 6973 / 6974

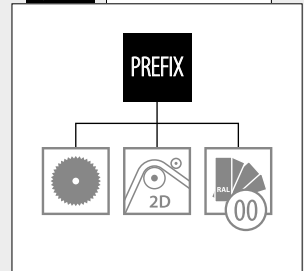

Q-INFO Aluminium

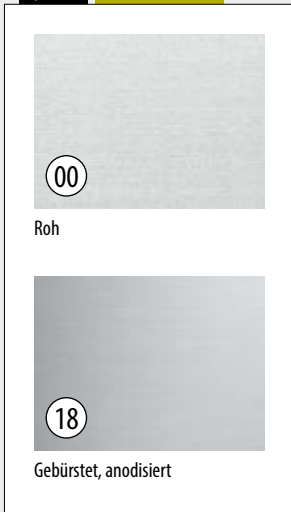

Q-INFO MOD 6970 / 6973

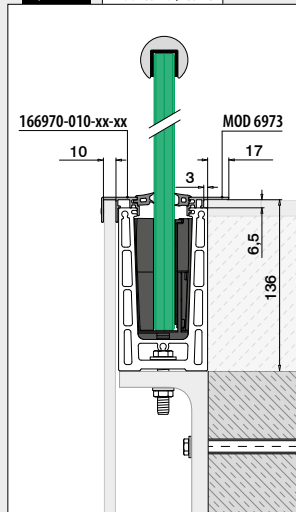

Q-INFO MOD 6974 / 6973

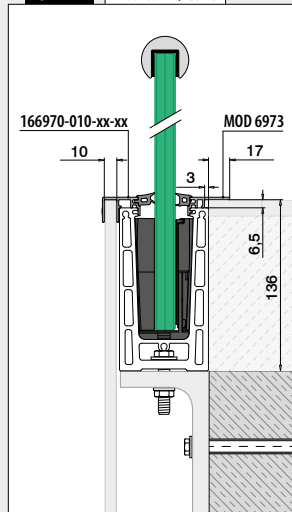

Q-INFO MOD 6974 / 6973

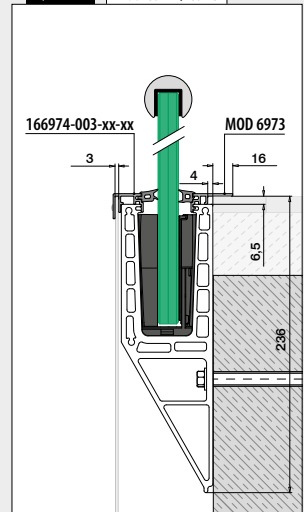

Kantenschutz

Kantenschutzprofile

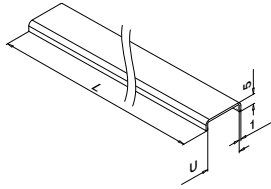

MOD 6940

V4A	316	Gebürstet				
OUTDOOR			U	Q	T	
146940-025-18-12	18,5	Q-98	16,76 - 17,52	L = 2500 mm		
146940-025-22-12	22,5	Q-99	20,76 - 21,52	L = 2500 mm		
146940-050-14-12	14,5	Q-111	12,76 - 13,52	L = 5000 mm		
146940-050-18-12	18,5	Q-98	16,76 - 17,52	L = 5000 mm		
146940-050-22-12	22,5	Q-99	20,76 - 21,52	L = 5000 mm		
146940-050-26-12	26,5	Q-112	24,76 - 25,52	L = 5000 mm		



Kantenschutz

Ecken

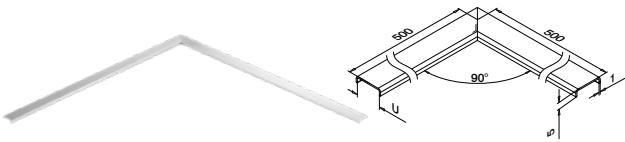

MOD 6340

V4A	316	Gebürstet			
OUTDOOR			U	T	
146340-500-18	18,5	16,76 (8-0,76-8) - 17,52 (8-1,52-8)	1		
146340-500-22	22,5	20,76 (10-0,76-10) - 21,52 (10-1,52-10)	1		
146340-500-26	26,5	24,76 (12-0,76-12) - 25,52 (12-1,52-12)	1		

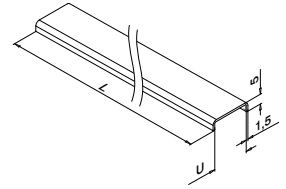

MOD 6940

Aluminium	Roh				
OUTDOOR		U	Q	T	
166940-050-18-00	18,5	Q-98	16,76 - 17,52	L = 5000 mm	
Aluminium	Gebürstet				
OUTDOOR		U	Q	T	
166940-025-18-18	18,5	Q-98	16,76 - 17,52	L = 2500 mm	
166940-025-22-18	22,5	Q-99	20,76 - 21,52	L = 2500 mm	
166940-050-18-18	18,5	Q-98	16,76 - 17,52	L = 5000 mm	
166940-050-22-18	22,5	Q-99	20,76 - 21,52	L = 5000 mm	



Q-INFO | MOD 6940 / 6340 / 6944

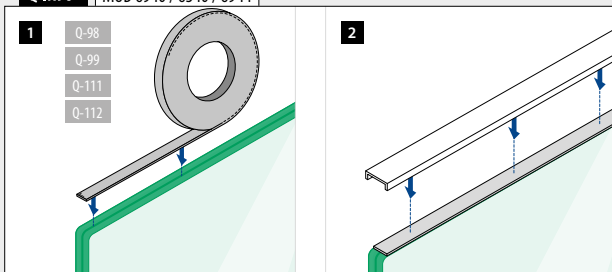

Q-INFO | MOD 69x0 | 304 | 316 | V2A | V4A

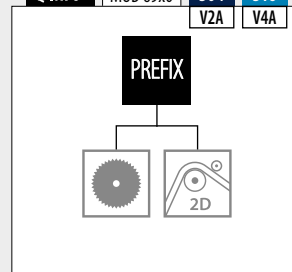

Q-INFO | MOD 694x | Aluminium

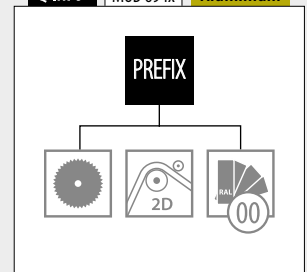

Glasleistenrohre

Glasleistenrohre

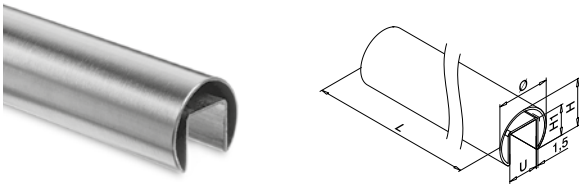

**MOD 6920**  
Ø 42,4 mm

V2A	304	Gebürstet				
INDOOR		U	H	H1		
136920-042-25-12	24	37	24			L = 2500 mm
136920-042-50-12	24	37	24			L = 5000 mm
V4A	316	Gebürstet				
OUTDOOR		U	H	H1		
146920-042-50-12	24	37	24			L = 5000 mm



Glasleistenrohre

Gummieinlagen



**MOD 5124**  
Zubehör  
U = 24 mm

Mono.		T	
205124-050-11	12		L = 5000 mm
205124-050-15	15		L = 5000 mm
205124-050-19	19		L = 5000 mm
Lam.		T	
205124-050-11	12,76 (6-0,76-6) - 13,52 (6-1,52-6)		L = 5000 mm
205124-050-17	16,76 (8-0,76-8) - 17,52 (8-1,52-8)		L = 5000 mm
205124-050-22	20,76 (10-0,76-10) - 21,52 (10-1,52-10)		L = 5000 mm

Glasleistenrohre

Verbinder

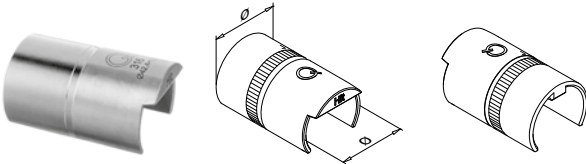

**MOD 6792 - EASY HIT®**

V2A	304	Roh			
INDOOR		Ø			
136792-042		für 42,4 x 1,5			2
V4A	316	Roh			
OUTDOOR		Ø			
146792-042		für 42,4 x 1,5			2



Glasleistenrohre

Endkappen



**MOD 6732**

V2A	304	Gebürstet			
INDOOR		Ø			
136732-042-12		42,4 x 1,5			2
V4A	316	Gebürstet			
OUTDOOR		Ø			
146732-042-12		42,4 x 1,5			2



Q-INFO MOD 6792

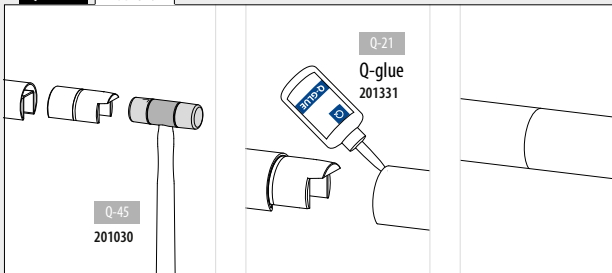

Q-INFO MOD 6920

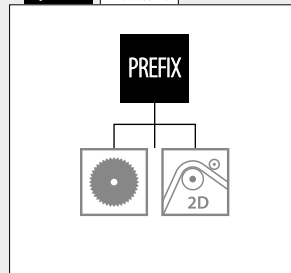

Q-INFO MOD 6920 / 5124 / 6732

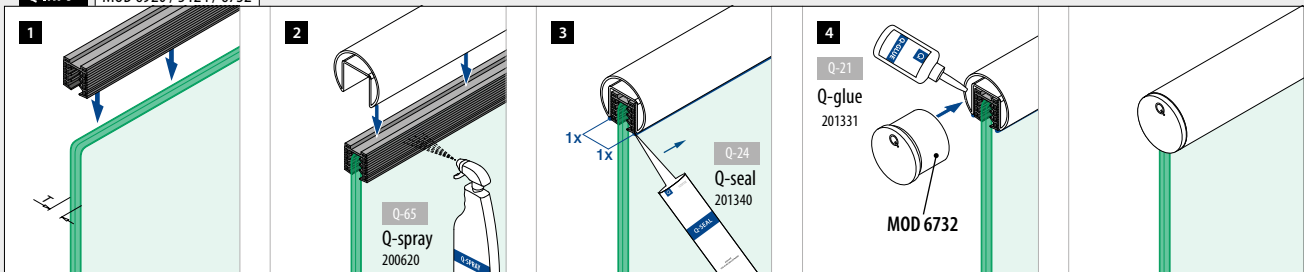

U-Profile **Quadratisch**

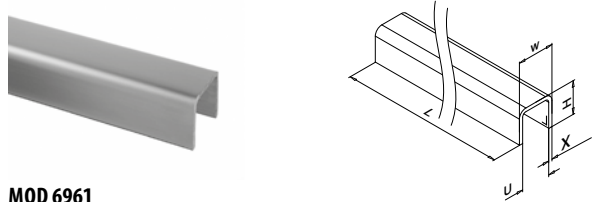

**MOD 6961**

V2A	304	Gebürstet						
INDOOR			U	X	T	W	H	
136961-050-24-12	24	2	8 - 21,52	28	26	L = 5000 mm		

V4A	316	Gebürstet						
OUTDOOR			U	X	T	W	H	
146961-050-24-12	24	2	8 - 21,52	28	26	L = 5000 mm		



U-Profile **Ecken** **Quadratisch**

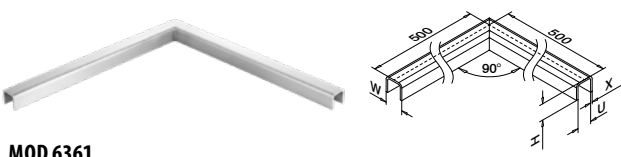

**MOD 6361**

V4A	316	Gebürstet						
OUTDOOR			U	X	T	W	H	
146361-24	24	2	8 - 21,52	28	26	1		

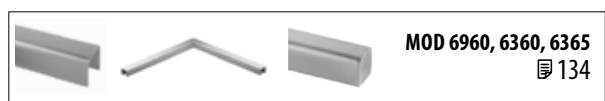

U-Profile **Gummieinlagen**



**MOD 5124**

**Zubehör**  
U = 24 mm

Mono.	T	
205124-050-15	15	L = 5000 mm
205124-050-19	19	L = 5000 mm

Lam.	T	
205124-050-11	12,76 (6-0,76-6) - 13,52 (6-1,52-6)	L = 5000 mm
205124-050-17	16,76 (8-0,76-8) - 17,52 (8-1,52-8)	L = 5000 mm
205124-050-22	20,76 (10-0,76-10) - 21,52 (10-1,52-10)	L = 5000 mm

U-Profile **Endkappen** **Quadratisch**

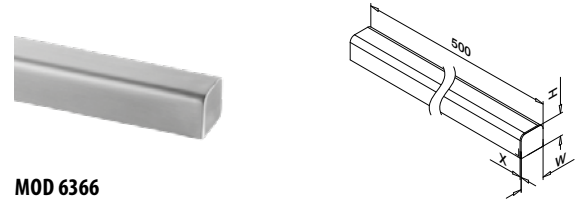

**MOD 6366**

V4A	316	Gebürstet						
OUTDOOR			U	X	T	W	H	
146366-24	24	2	8 - 21,52	28	26	1		

**Q-INFO** MOD 6961 / 6361

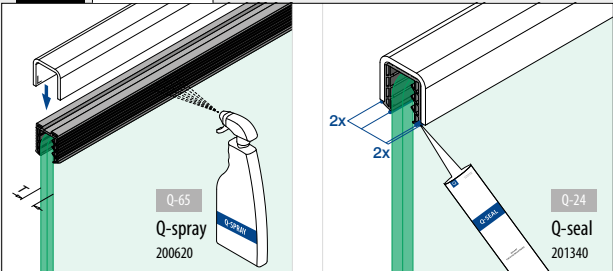

**Q-INFO** MOD 6961

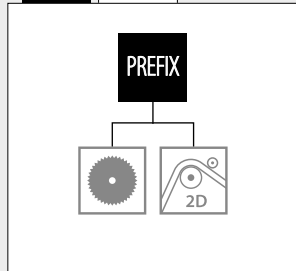

**Q-INFO**

**MEHR GLASLEISTENROHRE**



**Q-INFO**

**HANDLÄUFE**



**Q-INFO**

**GLASVERBINDER**



**Q-INFO**

**Q-LIGHTS**



# FINDEN SIE DEN RICHTIGEN ANKER FÜR IHR PROJEKT



q-ne.ws/3unM1X2

Bitte prüfen Sie die entsprechenden lokalen Normen bezüglich der Verwendung von Anker.

Diese Übersicht ist nicht berechnet oder getestet, sondern lediglich eine Empfehlung, basierend auf dem Q-railing Sortiment. Andere Anker und Optionen sind möglich. Unsere Services, wie Q-pac und Ankertabellen, helfen Ihnen bei der Wahl der richtigen Anker für Ihr Projekt. Bei Fragen kontaktieren Sie gerne auch Ihren Verkaufsberater.

Max. nutzbare  
Klemmstärke  
Fix T (mm)

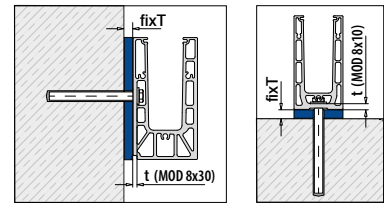

## EASY GLASS® SMART / PRIME

Montage / Für MOD	Anker	QS	Typ	Verwendung	Fix T (mm)		Anker	QS	Typ	Verwendung	Fix T (mm)	
Boden 8210 / 8410 t (mm) = 7 / 8,5	Chemisch	FÜR BETON			Smart / Prime			FÜR STAHL				
		QS-276	Q VMU-A M12x175	indoor	50 / 50	40	QS-224	M12 x 30	indoor	0 / 0	40	
		QS-277	Q VMU-A M12x175 A4	outdoor	50 / 50	40	+ QS-216	Für M12	indoor		40	
		QS-207	Q VMZ-IG 90 M12 A4	outdoor		40	QS-223	M12 x 30	outdoor	0 / 0	40	
		+ QS-225	M12 x 45	outdoor	0 / 0	40	+ QS-215	Für M12	outdoor		40	
	Mechanisch							QS-225	M12 x 45	outdoor	15,5 / 14	40
								+ QS-215	Für M12	outdoor		40
		FÜR BETON			Smart / Prime			FÜR HOLZ				
		QS-574	Q BSZ SU 10x100	indoor	35 / 35	42	QS-258	10 x 120		33 / 32	42	
		QS-575	Q BSZ SU 10x100 A4	outdoor	35 / 35	42						
		QS-576	Q BSZ SU 10x120	indoor	55 / 55	42						
		QS-577	Q BSZ SU 10x120 A4	outdoor	55 / 55	42						
		QS-561	Q SZ-S 12/10	indoor	3 / 1,5	41						
		QS-560	Q SZ-S 12/10 A4	outdoor	3 / 1,5	41						
		QS-563	Q SZ-S 12/30	indoor	23 / 21	41						
QS-562	Q SZ-S 12/30 A4	outdoor	23 / 21	41								
Boden F 8220 / 8420 t (mm) = 15 / 20	Chemisch	FÜR BETON			Smart / Prime			FÜR STAHL				
		QS-276	Q VMU-A M12x175 A4	indoor	45 / 58	40	QS-225	M12 x 45	outdoor	9,5 / 5	40	
		QS-277	Q VMU-A M12x175	outdoor	45 / 58	40	+ QS-215	Für M12	outdoor		40	
		QS-207	Q VMZ-IG 90 M12 A4	outdoor		40	FÜR HOLZ					
		+ QS-225	M12 x 45	outdoor	9,5 / 5	40	QS-258	10 x 120	indoor	25 / 20	42	
	Mechanisch											
		FÜR BETON			Smart / Prime			FÜR STAHL				
		QS-576	Q BSZ SU 10x120	indoor	50 / 45	42	QS-224	M12 x 30	indoor	6 / 5	40	
		QS-577	Q BSZ SU 10x120 A4	outdoor	50 / 45	42	+ QS-216	Für M12	indoor		40	
		QS-563	Q SZ-S 12/30	indoor	15 / 10	41	QS-223	M12 x 30	outdoor	6 / 5	40	
		QS-562	Q SZ-S 12/30 A4	outdoor	15 / 10	41	+ QS-215	Für M12	outdoor		40	
								QS-225	M12 x 45	outdoor	21 / 20	40
								+ QS-215	Für M12	outdoor		40
								FÜR HOLZ				
						QS-258	10 x 120	indoor	36 / 35	42		
Seiten 8230 / 8430 t (mm) = 4 / 5	Chemisch	FÜR BETON			Smart / Prime			FÜR STAHL				
		QS-207	Q VMZ-IG 90 M12 A4	outdoor		40	QS-224	M12 x 30	indoor	6 / 5	40	
		+ QS-225	M12 x 45	outdoor	3,5 / 2,5	40	+ QS-216	Für M12	indoor		40	
		+ QS-215	Für M12	outdoor		40	QS-223	M12 x 30	outdoor	6 / 5	40	
							+ QS-215	Für M12	outdoor		40	
	Mechanisch							QS-225	M12 x 45	outdoor	21 / 20	40
								+ QS-215	Für M12	outdoor		40
		FÜR BETON			Smart / Prime			FÜR STAHL				
		QS-571	Q BSZ SK 10x100	indoor	30 / 30	42	QS-224	M12 x 30	indoor	5 / 5	40	
		+ QS-286	Für Q BSZ SK 10	indoor		42	+ QS-216	Für M12	indoor		40	
		QS-572	Q BSZ SK 10x100 A4	outdoor	30 / 30	42	QS-223	M12 x 30	outdoor	5 / 5	40	
		+ QS-286	Für Q BSZ SK 10	outdoor		42	+ QS-215	Für M12	outdoor		40	
		QS-573	Q BSZ SK 10x120 A4	outdoor	50 / 50	42	QS-225	M12 x 45	outdoor	20 / 20	40	
		+ QS-286	Für Q BSZ SK 10	outdoor		42	+ QS-215	Für M12	outdoor		40	
		QS-561	Q SZ-S 12/10	indoor	5 / 5	41	FÜR HOLZ					
QS-560	Q SZ-S 12/10 A4	outdoor	5 / 5	41	QS-258	10 x 120	indoor	20 / 20	42			
QS-563	Q SZ-S 12/30	indoor	25 / 25	41								
QS-562	Q SZ-S 12/30 A4	outdoor	25 / 25	41								
Seiten Y 8240 / 8440 t (mm) = 5 / 5	Chemisch	FÜR BETON			Smart / Prime			FÜR STAHL				
		QS-276	Q VMU-A M12x175	indoor	55 / 55	40	QS-224	M12 x 30	indoor	5 / 5	40	
		QS-277	Q VMU-A M12x175 A4	outdoor	55 / 55	40	+ QS-216	Für M12	indoor		40	
		QS-207	Q VMZ-IG 90 M12 A4	outdoor		40	QS-223	M12 x 30	outdoor	5 / 5	40	
		+ QS-225	M12 x 45	outdoor	2,5 / 2,5	40	+ QS-215	Für M12	outdoor		40	
	Mechanisch							QS-225	M12 x 45	outdoor	20 / 20	40
								+ QS-215	Für M12	outdoor		40
		FÜR BETON			Smart / Prime			FÜR STAHL				
		QS-574	Q BSZ SU 10x100	indoor	40 / 40	42	QS-224	M12 x 30	indoor	5 / 5	40	
		QS-575	Q BSZ SU 10x120 A4	outdoor	40 / 40	42	+ QS-216	Für M12	indoor		40	
		QS-576	Q BSZ SU 10x120	indoor	60 / 60	42	QS-223	M12 x 30	outdoor	5 / 5	40	
		QS-577	Q BSZ SU 10x120 A4	outdoor	60 / 60	42	+ QS-215	Für M12	outdoor		40	
		QS-561	Q SZ-S 12/10	indoor	5 / 5	41	QS-225	M12 x 45	outdoor	20 / 20	40	
		QS-560	Q SZ-S 12/10 A4	outdoor	5 / 5	41	+ QS-215	Für M12	outdoor		40	
								FÜR HOLZ				
						QS-258	10 x 120	indoor	20 / 20	42		



**MOD 4410**

Stahl, verzinkt

INDOOR	QS	Typ	d	L	Box
254410-217	QS-276	Q VMU-A M12x175	M12	Ø 14 175	10

V4A

316

OUTDOOR	QS	Typ	d	L	Box
244410-217	QS-277	Q VMU-A M12x175	M12	Ø 14 175	10



**Q-INFO** MOD 4410

Montage-Informationen Q-Anker VMU-A

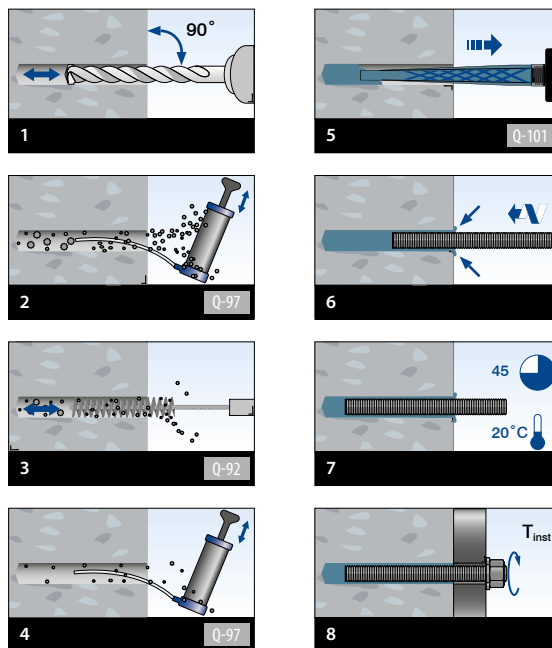

**MOD 4510**

OUTDOOR

OUTDOOR	QS	Typ	d	L	Box
244510-290	QS-207	Q VMZ-IG 90 M12 A4	M12	Ø 18 94	10

V4A

316

**Q-INFO** MOD 4510

Montage-Informationen Q-Anker VMZ-IG

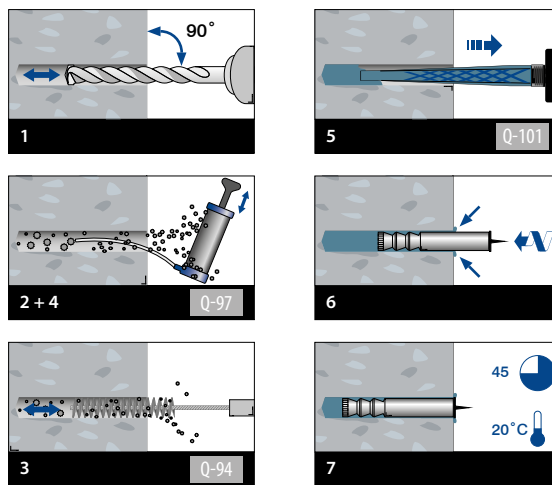

**MOD 0661 - DIN 933**

Stahl, verzinkt

INDOOR	QS	d	L	Box
250661-230	QS-224	M12	30	50

V4A

316

OUTDOOR	QS	d	L	Box
240661-230	QS-223	M12	30	50
240661-245	QS-225	M12	45	50

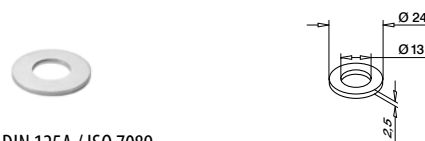

**MOD 0663 - DIN 125A / ISO 7089**

Stahl, verzinkt

INDOOR	QS	Für d	Box
250663-224	QS-216	M12	50

V4A

316

OUTDOOR	QS	Für d	Box
240663-224	QS-215	M12	50





Injektionsmörtel

**MOD 4089 / 4090**

Zubehör				
	Q	e		
204089-28	Q-104	280 ml	Q-VMU-A	1
204090-28	Q-101	280 ml	Q-VMZ	1



Ausbläser für Bohrlöcher

**MOD 4092**

Zubehör		
	Q	
204092	Q-97	1



Reinigungsbürste für Bohrlöcher

**MOD 4093**

Zubehör			
	Q		
204093-014	Q-93	Ø 14	1
204093-018	Q-94	Ø 18	1



Statikmischer für Injektionsmörtel

**MOD 4091**

Zubehör		
	Q	
204091	Q-103	1



Auspresspistole für Injektionsmörtel

**MOD 4095**

Zubehör		
	Q	
204095	Q-102	1

**Q-INFO** MOD 4089 / 4090

Anzahl Bohrlochfüllungen pro Injektionskartusche

<b>VMZ-IG</b>	<b>QS-207</b>	
Q-101 (280 ml)	21	
<b>VMU-A</b>	<b>QS-276</b>	<b>QS-277</b>
Q-104 (280 ml)	22	22



Q-101 / Q-104  
280 ml  
204090-28  
204089-28

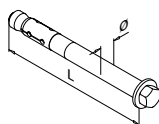

**MOD 4220**

Stahl, verzinkt

INDOOR						
	QS	Typ	Ø		L	
254220-285	QS-561	Q SZ-S 12/10	12	Ø 12	85	25
254220-211	QS-563	Q SZ-S 12/30	12	Ø 12	105	25

V4A 316

OUTDOOR						
	QS	Typ	Ø		L	
244220-285	QS-560	Q SZ 12/10 A4	12	Ø 12	85	25
244220-211	QS-562	Q SZ 12/30 A4	12	Ø 12	105	25



**Q-INFO** MOD 4220

Montage-Informationen Q-Anker SZ-S 12/10-30

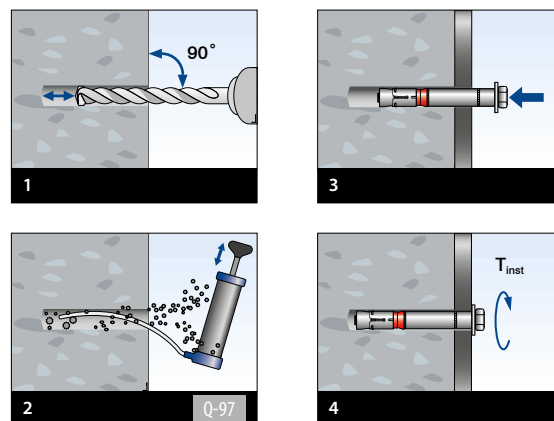



**MOD 4310**

Stahl, verzinkt

INDOOR	QS	Typ	Ø	L	⊞	
254310-110	QS-574	Q BSZ SU 10x100	10	Ø 10	100	50
254310-112	QS-576	Q BSZ SU 10x120	10	Ø 10	120	50

**V4A 316**

OUTDOOR

OUTDOOR	QS	Typ	Ø	L	⊞	
244310-110	QS-575	Q BSZ SU 10x100 A4	10	Ø 10	100	50
244310-112	QS-577	Q BSZ SU 10x120 A4	10	Ø 10	120	50



**MOD 4300**

Stahl, verzinkt

INDOOR	QS	Typ	Q	Ø	L	⊞	
254300-110	QS-571	Q BSZ SK 10x100	114	10	Ø 10	100	50

**V4A 316**

OUTDOOR

OUTDOOR	QS	Typ	Q	Ø	L	⊞	
244300-110	QS-572	Q BSZ SK 10x100 A4	114	10	Ø 10	100	50
244300-112	QS-573	Q BSZ SK 10x120 A4	114	10	Ø 10	120	50



**MOD 0665**

**V4A 316**

OUTDOOR

OUTDOOR	QS	Für d	⊞
240665-232	QS-286	M12	25

**Q-INFO MOD 4310**

Montage-Informationen Q-Anker Q BSZ SU 10x100 + 10x120 (A4)

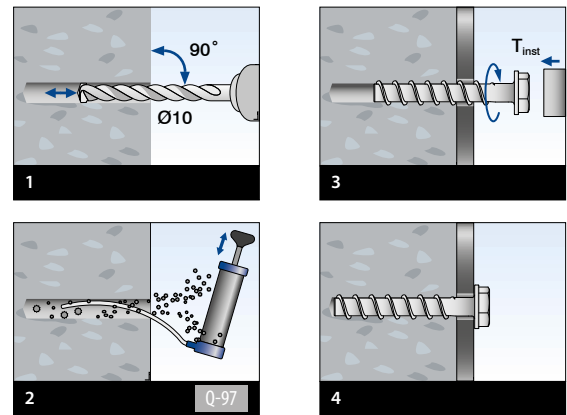

**Q-INFO MOD 4300**

Montage-Informationen Q-Anker Q BSZ SK 10x100 + 10x120 (A4)

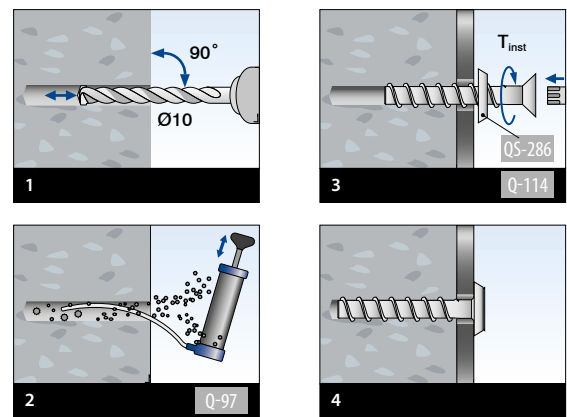

Bit 1/4", 5/16" Antrieb

**MOD 1016**

Zubehör

	Q	⊞	AW	L	⊞
201016-550	Q-114	5/16"	50	50	1

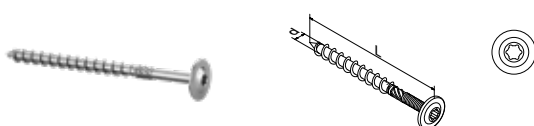

**MOD 0250**

Stahl, verzinkt

INDOOR	QS	Q	d	L	⊞
250250-012	QS-258	Q-114	10	120	50



**Q-INFO MOD 0250**

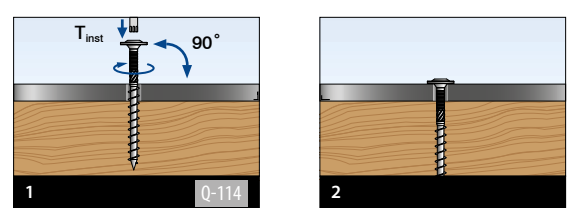

Montagezubehör

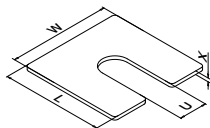

Unterlegscheiben zur Bodenmontage

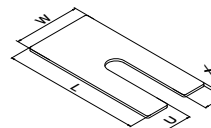

Unterlegscheiben zur Seitenmontage

**MOD 8216** - Easy Glass® Smart

	Aluminium		Roh		
	W	L	U	X	
168216-001	58	58	16	1	100
168216-002	58	58	16	2	100
168216-003	58	58	16	3	100

**MOD 8416** - Easy Glass® Prime

	Aluminium		Roh		
	W	L	U	X	
168416-001	69	69	24	1	100
168416-002	69	69	24	2	100
168416-003	69	69	24	3	100

**MOD 8236** - Easy Glass® Smart

	Aluminium		Roh		
	W	L	U	X	
168236-001	58	120	16	1	100
168236-002	58	120	16	2	100
168236-003	58	120	16	3	100

**MOD 8436** - Easy Glass® Prime

	Aluminium		Roh		
	W	L	U	X	
168436-001	58	135	16	1	100
168436-002	58	135	16	2	100
168436-003	58	135	16	3	100



Q-spray  
Für die reibungslose Montage

**MOD 0620**

	Zubehör		
	Q	e	
200620	Q-65	1000 ml	1

Verbindungsstifte

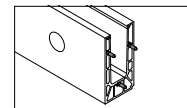
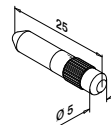

**MOD 3005**

V4A	316	Roh	
	<b>OUTDOOR</b>		
143005			6



Zubehör

Pflege und Reinigung



Q-protector  
Schützt Aluminium- und Edelstahlkomponenten direkt nach der Montage

**MOD 0602**

	Zubehör		
	Q	e	
200602	Q-63	500 ml	1

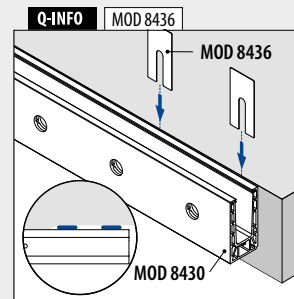
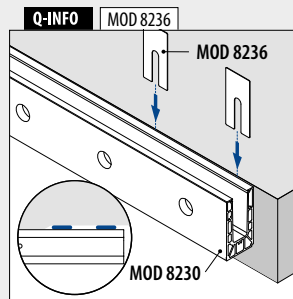
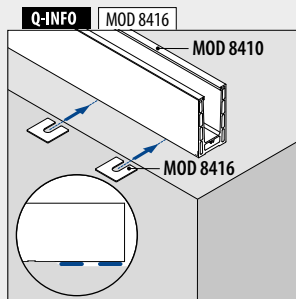
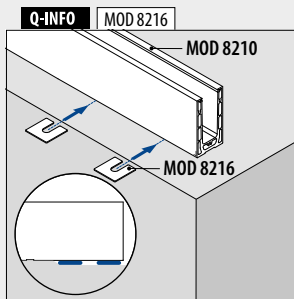
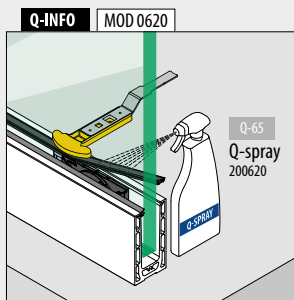

MONTAGEZUBEHÖR  
PFLEGE UND REINIGUNG

ZUBEHÖR



# MAßGEFERTIGTES GLAS

## Q-GLASS

Bestellen Sie die Glaselemente  
zeitgleich mit allen anderen  
Produkten für ihr Ganzglasgeländer

- Von monolithisches Glas bis hin zu 31,52 mm Verbundsicherheitsglas
- Optional mit matter, farbiger oder SentryGlas®-Folie
- Abgerundete Ecken und polierte Kanten auf Anfrage
- Optional mit vorgebohrten Löchern
- Gebogenes Glas

FORDERN SIE EIN  
ANGEBOT AN ODER  
BESTELLEN SIE DIREKT

Unser Verkaufsteam bespricht mit Ihnen  
gerne Ihr nächstes Geländerprojekt:  
Rufen Sie uns unter 02822 91569 0 bzw.  
089 24 887 460 an oder schreiben Sie uns  
eine E-Mail an [sales.de@q-railing.com](mailto:sales.de@q-railing.com).

- CE-Kennzeichnung
- Hohe Qualität
- Schnelle Lieferung
- All-inclusive-Preise
- Einfache Bestellung

Sparen Sie sich Zeit und Mühe und  
nutzen Sie unser Berechnungsblatt  
für die Berechnung Ihrer Glasmaße.

Direkt zum Glasberechnungsblatt:



[q-ne.ws/2VGBb34](https://q-ne.ws/2VGBb34)

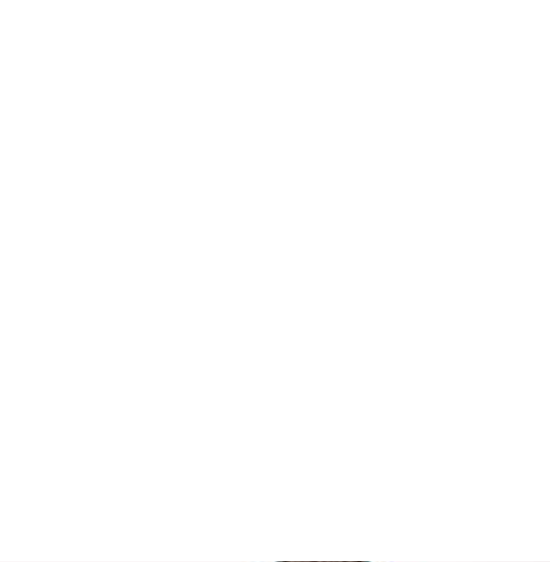

# PREFIX – IHR MEHRWERT

Zeit ist Geld – und die Zeit auf den Baustellen ist heutzutage knapp und scheint am teuersten zu sein. Warum also nicht komplett oder teilweise vorgefertigte Glasgeländer bestellen? Verlassen Sie sich dabei auf unsere Spezialisten, die alles genau nach Ihren Vorgaben vorbereiten. Damit erledigen Sie Baustelle nach Baustelle in Rekordzeit.

Easy Glass Smart und Prime sind unkomplizierte Systeme und bieten dennoch unzählige Möglichkeiten. Sie möchten kein Standardgeländer, sondern beispielsweise ein gebogenes Glasgeländer? Kein Problem! Außerdem sägen, fräsen und pulverbeschichten wir die Komponenten nach Ihren individuellen Wünschen. Geben Sie uns Ihre Daten an und wir bereiten alles vor, was Sie benötigen.

## **PREFIX** IHRE OPTIONEN BEI EASY GLASS SMART UND PRIME



### **Biegen**

Wir bieten 2D-Biegearbeiten bei Rohren, Glasleistenrohren, U-Profilen, Kantenschutzprofilen und Easy Glass Bodenprofilen an. Unser akkurater Service stellt sicher, dass Sie genau die Größen und Radien erhalten, die Sie benötigen. Gebogenes Glas für die Easy Glass Serie besitzt ein allgemeines bauaufsichtliches Prüfzeugnis (AbP).



### **Zuschneiden und Fräsen**

Maximalen Komfort bietet auch unser Zuschnittservice für Komponenten aus Edelstahl, Aluminium oder Holz. Dies umfasst Handläufe, Glasleistenrohre und Easy Glass Bodenprofile. Wir liefern die bestellten Produkte zudem auf Gehrung gesägt und mit vorgefrästen Bohrungen für beispielsweise LED-Spots.



### **Pulverbeschichtung**

Lassen Sie Bodenprofile, Glasleistenrohre, Endkappen oder andere Komponenten bequem in der RAL-Farbe Ihrer Wahl pulverbeschichten.

### **Benötigen Sie Hilfe bei einem Projekt?**

Wie Sie sehen, können wir Ihnen Arbeit abnehmen. Also zögern Sie nicht und lassen Sie uns die Vorarbeiten für Sie erledigen. Unser Verkaufsteam bespricht mit Ihnen gerne Ihr nächstes Geländerprojekt: Rufen Sie uns unter 02822 91569 0 bzw. 089 24 887 460 an oder schreiben Sie uns eine E-Mail an [sales.de@q-railing.com](mailto:sales.de@q-railing.com). Denn die Zeit, die Sie bei Ihrem aktuellen Projekt einsparen, können Sie schon für Ihr nächstes einsetzen.



**2D BIEGEN**



**ZUSCHNEIDEN**



**PULVERBESCHICHTUNG**

Um unseren Vorfertigungsservice zu nutzen,  
laden Sie einfach das Formular herunter und  
füllen es aus: [www.q-railing.com/prefix](http://www.q-railing.com/prefix).



[q-ne.ws/3c0p0mG](http://q-ne.ws/3c0p0mG)





# IHRE MONTAGE- HERAUSFORDERUNGEN GELÖST

EASY GLASS® SMART UND EASY GLASS® PRIME

ALLE INFORMATIONEN FINDEN SIE UNTER:  
[WWW.Q-RAILING.COM/SMART-PRIME](http://WWW.Q-RAILING.COM/SMART-PRIME)

WARTEN SIE NICHT LÄNGER –  
TAUCHEN SIE EIN IN DEN  
PRODUKTKATALOG 2021/2022!

Smart und Prime sind nur zwei Systeme aus unserem umfangreichen Sortiment. Lernen Sie auch unsere anderen Glas- und Pfostengeländer kennen. Das komplette Programm finden Sie in unserem 2021/2022 Katalog auf [www.q-railing.com/catalogue](http://www.q-railing.com/catalogue). Oder fragen Sie ein gedrucktes Exemplar an: kontaktieren Sie uns unter 02822 91569 0 bzw. 089 24 887 460 oder [sales.de@q-railing.com](mailto:sales.de@q-railing.com).



Q-RAILING  
CATALOGUE  
2021/2022



[q-ne.ws/3fsX8K5](https://q-ne.ws/3fsX8K5)

#### Q-railing

**Niederlassung Emmerich**  
Marie-Curie-Straße 8-14  
46446 Emmerich am Rhein  
Deutschland

T. 02822 91569 0  
F. 02822 91569 70  
WhatsApp 0152 0865 1286  
[sales.de@q-railing.com](mailto:sales.de@q-railing.com)

**Niederlassung München**  
Hanns-Schwindt-Straße 8  
81829 München  
Deutschland

T. 089 24887 460  
F. 089 24887 469 9  
WhatsApp 0152 0865 1286  
[sales.de@q-railing.com](mailto:sales.de@q-railing.com)

Es gelten unsere aktuellen AGB. Druckfehler und technische Änderungen vorbehalten.

Q-RAILING SMART/PRIME BROCHURE 2021, DE • LANGUAGE DE • NO CURRENCY • 900000001566